

デジタルセットトップボックス

BD-V372

取扱説明書

もくじ

ご使用の前に

| | |
|--|----|
| 安全上のご注意 | 3 |
| 全指向性 RF リモコンおよび STB 用無線 LAN アダプター使用時のご注意 | 5 |
| 使用上のご注意 | 7 |
| デジタル放送について | 11 |
| 付属品の確認 | 12 |
| リモコンに電池を入れる | 12 |
| 各部の名称と働き | 13 |

機器の接続

| | |
|-------------------------------|----|
| テレビにつなぐ | 15 |
| デジタル音声入力端子付きオーディオ機器につなぐ | 17 |
| ホームネットワーク対応機器をつなぐ | 17 |
| 双方向で使用する | 18 |
| USB-HDD をつなぐ | 19 |

付録

| | |
|--------------------------|----|
| 故障かな？と思ったら | 21 |
| 地上デジタル放送チャンネル一覧表 | 23 |
| 仕様 | 25 |
| How to Use BD-V372 | 43 |

ご使用の前に

安全上のご注意

安全にお使いいただくために、必ずお守りください。

この取扱説明書および製品には、製品を安全に正しくお使いいただき、お客様や他の方々への危害や財産への損害を未然に防止するために、いろいろな絵表示をしています。その表示と意味は次のようになっています。内容をよく理解してから本文をお読みください。

警告

この表示を無視して、誤った取り扱いをすると、人が死亡または重傷を負う可能性が想定される内容を示しています。

注意

この表示を無視して、誤った取り扱いをすると、人が障害を負う可能性が想定される内容および物的損害のみの発生が想定される内容を示しています。

絵表示の例



△ 記号は注意（警告を含む）しなければならない内容であることを示しています。図の中に具体的な注意事項が描かれています。



⊘ 記号は禁止（やってはいけないこと）を示しています。図の中や近くに具体的な禁止内容（左図は分解禁止）が描かれています。



● 記号は行動を強制したり指示したりする内容を示しています。図の中に具体的な指示内容（左図は電源プラグをコンセントから抜け）が描かれています。

警告

❖ 異常時の処置



画面が映らない・音が出ない・煙が出る・変なにおいがするなどのときや、本機を落としたりカバーを破損したりしたときは、電源を切り、電源プラグをコンセントから抜いて、ご加入のケーブルテレビ局にお問い合わせください。そのまま使用すると火災・感電の原因となります。



万一、内部に水や異物などが入った場合は、電源を切り、電源プラグをコンセントから抜いて、ご加入のケーブルテレビ局にお問い合わせください。そのまま使用すると火災・感電の原因となります。

❖ 設置



電源コードの上に重いものをのせたり、コードが本機の下敷きになったりしないようにしてください。また、コードをねじったり、引っ張ったり、加熱したり、熱器具に近づけたりしないでください。コードが傷んだらご加入のケーブルテレビ局に交換を依頼してください。そのまま使用すると破損して火災・感電の原因となります。



次のような使い方をしないでください。内部に熱がこもり、火災や故障の原因となるばかりか、周囲の器物に変形・変色・故障などの影響を与えることがあります。

- 押し入れや通気の悪いラックの中に設置する
- テーブルクロスを掛ける
- じゅうたんや布団の上に置く
- ビデオやオーディオ機器に直接重ねる
- 上に物をのせる



本機は使用していると上面・底面・側面が熱く感じられますが、異常ではありません。使用環境温度範囲は5℃～40℃です。40℃以上の高温になる環境では使用しないでください。



本機の上に火がついたろうそくなどの裸火を置かないでください。火災の原因となります。

❖ 使用環境



この機器に水が入ったり、濡れたりしないようにご注意ください。火災・感電の原因となります。雨天、降雪中、海岸、水辺での使用は特にご注意ください。



風呂、シャワー室では使用しないでください。火災・感電の原因となります。



交流100V以外では使用しないでください。この機器を使用できるのは日本国内のみです。クーラー用などの200Vコンセントには接続しないでください。また、船舶などの直流(DC)電源にも接続できません。火災の原因となります。

❖ 使用方法



本機の上に花瓶、コップ、化粧品、薬品や水などの入った容器または小さな金属物を置かないでください。こぼれたり、中に入ったりした場合、火災・感電の原因となることがあります。



濡れた手で本体および電源プラグを触らないでください。感電の原因となることがあります。



金属類や燃えやすいものを通風孔などから入れないでください。万一、異物が入った場合は電源を切り、電源プラグをコンセントから抜いて、ご加入のケーブルテレビ局にお問い合わせください。そのまま使用すると火災・感電の原因となります。



カバーを外したり、改造したりしないでください。内部には電圧の高い部分があり感電の原因となります。内部の点検・調整修理はご加入のケーブルテレビ局へご相談ください。



付属の電源コードはこの機器のみで使用することを目的とした専用品です。他の電気製品ではお使いになれません。他の電気製品で使用した場合、発熱により火災・感電の原因となることがあります。また電源コードは本製品に付属したものを以外は使用しないでください。他の電源コードを使用した場合、この機器の本来の性能が出ないことや、電流量不足による発熱により火災・感電の原因となることがあります。



付属以外の AC アダプターを使わないでください。破損・液もれや、過熱などにより、火災、けがや周囲の汚損の原因となります。



雷が鳴り出したら本体・アンテナ線や電源プラグには触れないでください。感電の原因となります。



注意

❖ 設置



直射日光が当たる場所や熱器具の近くに置くと、火災の原因となることがあります。



電源プラグはコンセントに根元まで確実に差し込んでください。差し込みが不完全ですと、発熱したりほこりが付着して火災の原因となることがあります。また、電源プラグの刃に触れると感電することがあります。



電源プラグは、根元まで差し込んでみゆるみがあるコンセントには接続しないでください。発熱して火災の原因となることがあります。ご加入のケーブルテレビ局にお問い合わせください。



ぐらついた台の上など不安定な場所に置かないでください。また、本機に乗ったりしないでください。落ちたり、倒れたりして危険です。けがの原因となることがあります。



調理台や加湿器のそばなど油煙、湿気、ほこりの多い場所に置かないでください。火災・漏電の原因となることがあります。



電源プラグを抜くときは、電源コードを引っ張らないでください。コードが傷つき、火災・感電の原因となることがあります。



STB 用無線 LAN アダプターを STB に接続する場合は、説明に従い STB の電源を切って接続してください。

❖ 使用方法



機器に乗らないでください。倒れたり、壊れたりしてけがの原因となることがあります。特に小さなお子様にはご注意ください。



静電気による破損を防ぐため、STB 用無線 LAN アダプターに触れる前に、身近な金属（ドアノブやアルミサッシなど）に手を触れて、身体の静電気を取り除くようにしてください。

❖ 保守・点検



定期的に通電している電源プラグのほこりを取り除いてください。通電している電源プラグにほこりが積もると絶縁不良となり、火災の原因になります。お手入れの際には電源プラグを抜き、乾いた布などで拭いてください。電源プラグを抜くときは、電源コードを引っ張らないでください。



3D視聴に関するご注意



3D 映像の視聴中に疲労、不快感等、異常を感じた場合は視聴を中止してください。



発達段階にあるお子様（特に 6 歳未満）の 3D 視聴は視力に影響を及ぼす可能性があるため、疲労や不快感がないか保護者の方がご注意ください。



3D 映画の視聴は適度に休憩をとってください。※ 長時間の視聴は疲労や不快感の原因となることがあります。

- ・本機の修理および内部の点検・調整はご加入のケーブルテレビ局にお問い合わせください。
- ・万一、故障したときは廃棄せずに、ご加入のケーブルテレビ局の指示に従ってください。
- ・お引っ越しなどの製品の移動、設置場所の変更は、ご加入のケーブルテレビ局へお問い合わせください。
- ・本文中の「ケーブルテレビ局」という表記は、お客様が契約しているケーブルテレビ局またはケーブルテレビセンターを示しています。

全指向性RFリモコンおよびSTB用無線LANアダプター使用時のご注意

本機は、RF リモコン通信機能および無線 LAN 通信機能を搭載しています。これらの機能を使用するときは、以下の点に注意してご使用ください。

電波についてのご注意

本機は、2.4 GHz と 5 GHz の周波数帯の電波を利用しています。2.4 GHz 帯は、下記①に示すようにいろいろな機器が使用しています。また、お客様に存在がわかりにくい機器として下記②に示すような機器もあります。

① 2.4 GHz を使用する主な機器の例

| | |
|-------------------------------|---------------------|
| • コードレスフォン | • Bluetooth 機能搭載機器 |
| • コードレスファクシミリ | • ワイヤレス AV 機器 |
| • 電子レンジ | • ゲーム機のワイヤレスコントローラー |
| • RF リモコン | |
| • 無線 LAN 機器 (IEEE802.11b/g/n) | • マイクロ波治療機器類 |

② 存在がわかりにくい 2.4 GHz を使用する主な機器の例

| | |
|-------------|--------------------|
| • 万引き防止システム | • 工場や倉庫などの物流管理システム |
| • アマチュア無線局 | • 鉄道車両や緊急車両の識別システム |

これらの機器と本機を同時に使用すると、電波の干渉により、通信がとぎれることがあります。

- 通信状況の改善方法としては以下の方法があります。
- 電波を発生している相手機器の電源を切る。
 - 干渉している機器との距離を離して設置する。(本機を干渉している機器から離してください)

次の場所では本機を使用しないでください。双方向通信ができなくなる場合があります。

- 本機以外の 2.4 GHz を利用する無線 LAN (IEEE802.11b/g/n)、また電子レンジなどの機器の磁場、静電気、電波障害が発生するところ。(環境により電波が届かない場合があります)
- ラジオからは離してお使いください。
- テレビにノイズが出た場合、本機がテレビ、ビデオ、BS チューナー、CS チューナーなどのアンテナ入力端子に影響を及ぼしている可能性があります。本機をアンテナ入力端子から遠ざけて設置してください。
- 携帯電話、PHS、ラジオの近くではできるだけ使用しないでください。
携帯電話、PHS、ラジオなどは、無線 LAN とは異なる電波の周波数帯を使用していますので、これらの機器を近くで使用しても、無線 LAN の通信およびこれらの機器の通信には影響しません。
ただし、これらの機器を無線 LAN 製品に近づけた場合は、無線 LAN 製品が発する電磁波の影響によって、音声や映像にノイズが発生する場合があります。

表記の意味および機器認定について

■ 2.4 GHz 無線 LAN 表記の意味について



- 「2.4」 : 2.4 GHz 帯を使用する無線設備を示す
 「DS/OF」 : 変調方式 DS-SS 方式 / OFDM 方式を示す
 「4」 : 想定干渉距離が 40 m 以下であること
 「」 : 全帯域を使用し、かつ移動体識別装置の帯域を回避可能であることを意味する

■ 本機が対応する無線 LAN 規格について

本機は、下記の記号に記載された規格で採用された無線通信チャンネルに対応した製品であることを意味します。無線アクセスポイントについても、この記号がある製品でご使用いただくことをお勧めします。

| |
|-----------------|
| IEEE802.11b/g/n |
| IEEE802.11a/n |
| W52 W53 W56 |

| タイプ | チャンネル | 周波数帯域 |
|-----|---|------------------------------|
| W52 | 36,40,44,48ch | 5.2 GHz 帯 (5150-5250 MHz) |
| W53 | 52,56,60,64ch | 5.3 GHz 帯 (5250-5350 MHz) |
| W56 | 100,104,108,112,116,120,124,128,132,136,140ch | 5.6 GHz 帯 (5470-5725 MHz) |

■ 無線 LAN の性能表示などの記載について

- 本機の通信速度 (300/54/11 Mbps) についての記載は、IEEE802.11 の無線 LAN 規格による理論上の最大値であり、実際のデータ転送速度 (実効値) を示すものではありません。
- 実際のデータ転送速度は、周囲の環境条件 (通信距離、障害物、電子レンジなどの電波環境要素、ネットワークの使用状況など) に影響します。
- [IEEE802.11n] 規格に準拠した製品のため、他社のドラフト準拠製品との通信を保証するものではありません。

■ 機器認定について

本機は電波法に基づく技術基準適合証明を受けていますので、無線局の免許は不要です。ただし、本機に以下の行為をすることは、電波法で禁止されています。

- 分解 / 改造する。
- 無線 LAN アダプターの定格銘板をはがす。
- 5.2 GHz/5.3 GHz 帯無線 LAN (W52/W53) を使って屋外で通信を行う。

周波数表示の見方 (本機背面のラベルに記載)



- 「2.4」 : 2.4 GHz 帯を使用する無線設備を示す
 「DS」 : 変調方式 DS-SS 方式を示す
 「1」 : 想定される干渉距離 (約 10 m) を示す
 「」 : 全帯域を使用し、かつ移動体識別装置の帯域を回避可能であることを意味する

使用範囲について

ご家庭内での使用に限りです（通信の環境により通信距離が短くなる場合があります）。

次のような場合、電波状態が悪くなったり電波が届かなくなるのが原因で、双方向通信がとぎれて、操作できなくなったりします。

- ・鉄筋コンクリートや金属の使われている壁や床を通して使用する場合。
- ・大型の金属製家具の近くなど。
- ・2.4 GHz を利用する無線 LAN (IEEE802.11b/g/n)、また電子レンジなどの機器の磁場、静電気、電波障害が発生するところ。
- ・集合住宅（アパート・マンションなど）にお住まいで、お隣で使用している電子レンジ設置場所が本機に近い場合。なお、電子レンジは、使用してなければ電波干渉は起こりません。

電波の反射について

本機が通信する電波には、直接届く電波（直接波）と、壁や家具、建物などに反射してさまざまな方向から届く電波（反射波）があります。これにより、障害物と反射物とのさまざまな反射波が発生し、電波状態の良い位置と悪い位置が生じ、双方向通信がうまくできなくなることがあります。このようなときは、RF リモコンや本機の場所、または無線 LAN アクセスポイントを少し動かしてみてください。RF リモコンと本機の間、または無線 LAN アクセスポイントと本機の間を人間が横切ったり、近づいたりすることによっても反射波の影響で双方向通信がとぎれたりすることがあります。

⚠️ ご注意

- ・本機の使用によって発生した損害については、法令上賠償責任が認められる場合を除き、当社は一切の責任を負いませんので、あらかじめご了承ください。
- ・本機は、すべての無線 LAN 機器との接続動作を保証するものではありません。
- ・弊社ではお客様のネットワーク接続環境、接続機器に関する通信エラーや不具合について、一切の責任を負いかねます。あらかじめご了承ください。プロバイダまたは各接続機器のメーカーにお問い合わせください。
- ・IEEE802.11a/n (5.2 GHz/5.3 GHz) 帯の電波を使って、屋外で通信をしないでください。
- ・法令により、5.2 GHz/5.3 GHz 帯無線機器を屋外で使用することは禁止されています。
- ・日本国内でのみ使用できます。
- ・利用権限のない無線ネットワークには接続しないでください。
無線ネットワーク環境の自動検出のときに、利用権限のない無線ネットワーク (SSID ※) が表示されることがありますが、権限の無い無線ネットワークにアクセスすると不正アクセスと見なされる恐れがあります。
※ 無線 LAN で特定のネットワークを識別するための名前のことです。この SSID が双方の機器で一致した場合、通信可能になります。

安全にお使いいただくために

- ・高精度な制御や微弱な信号を取り扱う電子機器の近くでは使用しないでください。電子機器に誤動作するなどの影響を与え、事故の原因となる恐れがあります。
- ・航空機や病院など、使用を禁止された場所では使用しないでください。電子機器や医療用電気機器に影響を与え、事故の原因となる恐れがあります。医療機関の指示に従ってください。

ご注意いただきたい電子機器の例

補聴器、ペースメーカー、その他医療用電気機器、火災報知器、自動ドア、その他自動制御機器など。ペースメーカー、その他医療用電気機器をご使用される方は、該当の各医療用電気機器メーカーまたは販売業者に電波による影響についてご確認ください。

⚠️ ご注意

この機器の使用周波数帯では、電子レンジなどの家電製品や産業・科学・医療用機器のほか、工場の製造ラインなどで使用されている移動体識別用の構内無線局（免許を要する無線局）および特定小電力無線局（免許を要さない無線局）並びにアマチュア無線局（免許を要する無線局）が運用されています。

- 1 この機器を使用する前に、近くで移動体識別用の構内無線局および特定小電力無線局並びにアマチュア無線局が運用されていないことを確認してください。
- 2 万一、この機器から移動体識別用の構内無線局に対して有害な電波干渉の事例が発生した場合には、すみやかに電波の発射を停止したうえで、お問い合わせ窓口 (cn_support@db.pioneer.co.jp) にご連絡いただき、混信回避のための処置など（たとえば、パーティションの設置など）についてご相談ください。
- 3 その他、この機器から移動体識別用の特定小電力無線局あるいはアマチュア無線局に対して有害な電波干渉の事例が発生した場合など、何かお困りのことが起きたときは、お問い合わせ窓口 (cn_support@db.pioneer.co.jp) へお問い合わせください。

使用上のご注意

電源プラグはなるべく抜かないでください

本機はスタンバイ中でも必要な情報を受信することがあります。長時間使用しないとき、トラブル発生時、お手入れのとき以外は、なるべく電源プラグをコンセントから抜かないでください。

動かない画像を長時間映さないでください。

本機に接続されたテレビやプラズマディスプレイに動かない画像を長時間映していると、画面に映像が焼き付いて影のように画面に残る恐れがあります。動かない画像を長時間映さないでください。

時刻設定について

本機では放送局から送られてくる時刻データに基づいて内部の時刻を設定しています。常に正しい時刻が設定されていますので、お客様に設定していただく必要はありません。

降雨対応放送

激しい降雨などによりケーブルセンターでの衛星放送の受信状況が悪くなり、番組が視聴しにくくなる場合があります。BS デジタル放送には、視聴に必要な最低限の情報を降雨に強い方式で送る降雨対応放送が用意されています。映像・音声かとぎれるようなときは、降雨対応放送を選ぶと、番組かとぎれることなく視聴できます。(降雨対応放送を行っていないチャンネルでは選べません。)

CAS カード (IC カード) について

- CAS カードは放送をお楽しみいただくための大切なカードです。CAS カードを挿入しないと有料放送を視聴できません。CAS カードは常時、挿入口に入れておいてください。
- 破損や紛失などのときは、ご加入のケーブルテレビ局にお問い合わせください。
- 本機では、CAS カードは「IC カード」と表示されることがあります。

CAS カード取り扱い上の注意

- CAS カードを折り曲げたり、傷をつけたり、変形させたりしないでください。
- CAS カードの上に重いものを置いたり踏みつけたりしないでください。
- CAS カードに水をかけたり、濡れた手で触ったりしないでください。
- CAS カードの IC (集積回路) 部には手を触れないでください。
- CAS カードの分解加工はしないでください。
- ご使用中に CAS カードの抜き差しをしないでください。視聴できなくなることがあります。
- 本機に CAS カード以外のカードを挿入しないでください。故障や破損の原因となります。
- 裏向きや逆方向から挿入しないでください。挿入方向を間違えると CAS カードは機能しません。

録画について

- 大切な録画のときは、本機に接続した機器で事前に試し録画を行い、正しく録画できることを確認しておいてください。
- 本機に接続した機器に録画 (録音) した内容の長期的な保管は保証できません。あくまでも一時的な保管場所としてご使用ください。

著作権について

本機で録画・録音したものは個人として楽しむなどのほかは、著作権法上、権利者に無断で使用できません。私的目的で録画したもので、著作権者等に無断で販売したり、インターネット上で公衆に送信したり、営利目的で放映すると著作権侵害となります。

免責事項

- 本機の不具合で録画を正常に行えなかったときの責任は負いかねますので、あらかじめご了承ください。
- 本機や接続機器の故障、受信障害・停電など、万一何らかの不具合により、録画・編集されなかったときの内容の補償、録画・編集されたデータの損失、ならびにこれらに関するその他の直接・間接の損害につきましては、当社は責任を負いません。あらかじめご了承ください。

USB-HDD、LAN-HDD に録画するときのご注意

※ 本書では HDD（ハードディスク）を HDD と表記しています。

- ホームネットワーク機器で録画予約を使用する場合は、スタンバイ設定を通常モードにすることをお勧めします。
- ネットワークの通信が混雑していると、正しく録画できないことがあります。
- 接続している機器の性能や状態によって録画が停止したり、正しく録画できない場合があります。
- 録画時間が短いときは、ハードディスクに保存されないことがあります。また、コンテンツやチャプターの編集で指定した時間の間隔が短いときは、編集ができないことがあります。
- 視聴年齢制限番組やコピー制御番組などの切り換わりで、録画番組が分割されることがあります。
- USB-HDD の時間指定録画の場合は、番組の切り換わり毎に録画番組が分割されます。また、次の番組の録画準備のため、前の番組の最後が約 10 秒切れることがあります。
- 録画が禁止された番組は録画できません。
- 時間指定録画で録画中に録画禁止の番組が始まったときは、録画は中断されます。録画が可能な状態になると、再び録画が始まります。
- LAN-HDD の録画はダビング 10 には対応していませんので、1 回だけ録画可能な番組（コピーワンス）として録画されます。
- USB-HDD で連続した番組を予約録画したときは、次の予約の録画準備のため、前の番組の最後が約 10 秒切れることがあります。
- LAN-HDD で連続した番組を予約録画したときは、次の予約の録画準備のため、前の番組の最後が約 1 分 40 秒切れることがあります。
- USB-HDD と LAN-HDD で連続した番組を予約録画したときは、次の予約の録画準備のため、前の番組の最後が約 45 秒切れることがあります。
- HDD の残量が不足しているときは録画できません。
- HDD の電源がオフまたは USB/LAN ケーブルが抜けていると録画できません。
- 市販の DLNA 録画に対応した機器を本機に接続しても、正しく録画できない場合があります。
- USB-HDD の録画は、録画画質の設定にかかわらず、すべて一度「DR」で録画されます。その後、本機が録画などをしていないときに設定した録画画質に変換します。「DR」以外の録画画質で録画する場合は、「DR」で録画するときよりも一時的に大きな空き容量（残量時間）が必要になりますので、ご注意ください。
- 音声多重番組を録画画質 2 倍～7 倍で録画した場合は、主音声のみ録画されます。再生時に音声を切り替えることはできませんので、副音声をお楽しみいただく場合は録画画質「DR」での録画をおすすめします。

その他

- 録画機器の状態や放送内容の変更によっては録画できないことがあります。
- 放送時間の変更や番組が延長された場合、正しく録画できないことがあります。
- 予約した番組の前の番組が時間延長になった場合、予約を開始しようとしたときに、放送局から送られてくる番組の開始時刻の情報が正しく更新されないことがあります。このときは録画できません。

USB-HDD を使用するときのご注意

- USB-HDD を本機に登録すると、本機専用のハードディスクとして初期化され、それまでハードディスク内に保存していた録画番組などのデータは全て削除されます。削除したデータの復元はできません。
- 登録を削除した USB-HDD を本機で再び使用する場合、もう一度登録が必要です。この場合、登録時に初期化されるため、USB-HDD に録画していた番組は全て削除されます。

- 本機に登録した USB-HDD で録画した番組は、本機のみで再生できます。他の機器にこの USB-HDD を接続して再生することはできません。
- USB-HDD に録画した番組を他のホームネットワーク対応機器で再生するためには、録画終了後しばらくお待ちいただいたあとに録画リストを表示してください。
- 修理などで、本機を初期化する、または本機を交換した場合、それまで使用していた USB-HDD は未登録として認識されるため、もう一度登録して使用することになります。この場合、登録時に初期化されるため、USB-HDD に録画していた番組は全て削除されます。このようなときは、録画していた番組の復元はできません。あらかじめご了承ください。

ホームネットワーク機能に関するご注意

ホームネットワークについて

- ネットワークの通信が混雑していると、録画・再生・配信・ダビング中に映像が途切れたり、正しく動作できないことがあります。また、ネットワーク上の機器やサーバ上のファイルが正しく表示されないこともあります。
- LAN ケーブル（有線 LAN）で機器と接続するときは、1000/100BASE 対応機器のご利用をお勧めします。
- 無線 LAN 使用時に映像や音声途切れるときは、本機の場所、または無線 LAN アクセスポイントを少し動かして、通信状態が良くなるか確認してください。それでも改善できないときは、有線 LAN での使用をお勧めします。
- 接続機器の性能や状態によっては、正しく動作できないことがあります。
- 接続している機器にインターネットセキュリティソフトウェアなどがインストールされていると、ネットワークに接続できないことがあります。
- 当社は本機とネットワーク上で接続している機器の不具合やファイルまたはデータの破損などに関して一切の責任を負いかねますので、あらかじめご了承ください。接続している機器のメーカーにお問い合わせください。
- 接続している機器の種類やソフトウェアのバージョンによっては働かない機能があります。
- すべてのホームネットワーク対応機器との接続動作を保証するものではありません。

ホームネットワーク視聴・再生について

- 本機で視聴可能な番組のみ、接続している機器で視聴できます。未契約チャンネルの番組を視聴することはできません。
- 本機で受信した放送番組を接続している機器で視聴するときは、実際の放送よりも数秒遅れます。
- 本機の状態によっては、接続している機器で視聴や再生ができないことがあります。
- ネットワーク上の複数の機器が同じファイルを同時に再生すると、再生が停止することがあります。

接続しているサーバについて

- ホームネットワークを使ってサーバに保存されているファイルを再生するには、あらかじめサーバが本機を認証（許可）している必要があります。認証（許可）方法は接続しているサーバによって異なります。詳しくはサーバの取扱説明書をご確認ください。
- サーバに保存されているコンテンツが本機で対応していないフォーマットのときは再生できません。
- 対応しているファイルの形式は接続している機器（サーバ）によって異なります。接続している機器が対応していない形式のファイルは表示されません。詳しくはお使いの機器（サーバ）のメーカーにお問い合わせください。
- サーバによっては本機が対応していないフォーマットを変換（トランスコード）して出力できるものもあります。詳しくはサーバの取扱説明書をご確認ください。
- サーバに保存されているファイルを再生する場合、推奨チューナーから録画したものの以外は、再生できないことがあります。
- サーバに保存されているコンテンツの一部、またはすべてにコピーガードがかかっているときは再生できません。

Web アクセスについて

- Web アクセス機能をお使いになるためには、別途、インターネット利用サービスに加入していただく必要があります。
- Web アクセス中にリモコンまたは本体ボタンが長時間動作しなくなったときは、本機前面パネルのリセットボタンを押してください。
- Web ページの構成によっては、文字が正しく表示されないことがあります。

設置について

- 本機の受信周波数帯域（90 MHz～1 GHz）を使用する携帯電話などの機器や本機周辺に設置する機器を本機に近づけ過ぎると、相互干渉により映像や音声に乱れが出る場合があります。これらの機器とは適度に離してご使用ください。
- 本機背面の冷却用ファンや通風孔をふさぐような狭いところに設置しないでください。
- 使用環境温度範囲は5℃～40℃です。40℃以上の高温になる環境では使用しないでください。

お手入れについて

ベンジン、シンナーなどで拭いたり、殺虫剤などの揮発性のものをかけたりしますと、変質したり、塗料がはげたりすることがありますのでおやめください。汚れがひどいときは、水で薄めた中性洗剤に浸した布をよく絞って拭き取り、乾いた布で仕上げてください。

免責事項

- お客様または第三者がこの製品の使用誤り、使用中に生じた故障、その他の不具合またはこの製品の使用によって受けられた損害については、法令上賠償責任が認められるときを除き、当社は一切その責任を負いません。あらかじめご了承ください。
- データ放送の双方向サービスなどで本機に記憶されたお客様の情報の一部、またはすべてが変化したり消失したときの損害や不利益についての責任は負いかねますので、あらかじめご了承ください。
- 本機は第三者が提供するソフトウェアをインストールすることができますが、当該ソフトウェアを使用したこと又は使用できなかったことから生じる一切の損害（利益の逸失、ビジネスの中断、情報の消失・棄損などによる損害を含みますが、これに限定されません）に関しては、一切の責任を負いませんので、あらかじめご了承ください。
- 第三者が提供するソフトウェア、コンテンツのサービスは、サービス提供者側の都合により予告なく、変更、中断、中止される可能性があります。当社は、そのような事態に対していかなる責任も負いません。当社は、第三者提供サービスの継続や利用可能期間について、いかなる保証もしません。

その他

持ち運ぶときは、衝撃を与えないようにしてください。故障の原因となります。

ご注意

- この取扱説明書に記載のイラストはイメージであり、実物とは形状が異なる場合があります。

- 本機は、ロヴィコーポレーションの米国特許および他の知的所有権によって保護された、著作権保護技術を搭載しています。解析や改造は禁止されていますので行わないでください。
- 本機を用いた有料サービスを国外で受けることは、有料サービス契約上禁止されていますのでおやめください。

この装置は、クラス B 情報技術装置です。この装置は、家庭環境で使用することを目的としていますが、この装置がラジオやテレビジョン受信機に近接して使用されると、受信障害を引き起こすことがあります。取扱説明書に従って正しい取り扱いをしてください。

VCCI-B

デジタル放送について

デジタル放送の特長

デジタル放送には、下記の特長があります。

- **デジタルハイビジョン**

高精細なデジタルハイビジョン放送があります。デジタルハイビジョン放送の画質をお楽しみいただくときは、ハイビジョン対応のテレビに接続してください。通常のテレビでも、そのテレビに応じた画質でデジタルハイビジョン放送をお楽しみいただけます。また、地上アナログテレビ放送とほぼ同等の画質のデジタル標準テレビ放送もあります。

- **多チャンネル放送**

デジタル信号圧縮技術により、より多くのチャンネルがお楽しみいただけます。テレビ放送、ラジオ放送、データ放送などが放送されています。

- **データ放送**

データ放送では、必要な情報を選んで表示できます。たとえば、最新のニュースやお住まいの地域の天気予報をいつでもご覧いただけます。独立したデータ放送番組のほか、ご覧になっているテレビ放送、ラジオ放送と一緒に放送されるデータ放送があります。テレビ放送、ラジオ放送と一緒に放送されるデータ放送では、ニュースや天気予報といった情報のほか、番組と連動して番組内容の補足情報が放送され、テレビ画面と一緒に表示してお楽しみいただけます。

- **サラウンド・ステレオ**

最大 5.1 チャンネルのサラウンド・ステレオ放送も放送されています。HDMI 端子、またはデジタル音声入力端子のある AAC 方式対応のオーディオ機器に接続していただくと、臨場感のある放送をお楽しみいただけます。

BS デジタル放送、地上デジタル放送について

- **BS デジタル放送**

放送衛星 (BS) を利用したデジタル放送です。デジタルハイビジョン放送を中心とした放送を行っています。

- **地上デジタル放送**

地上に設置された放送電波塔から電波を送る「地上波」を利用したデジタル放送です。

付属品の確認

リモコン×1

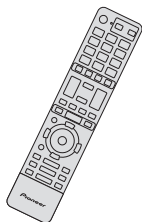

単3形乾電池×2



ACアダプター×1
電源コード

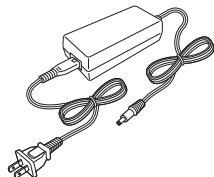

取扱説明書（本書）

リモコンに電池を入れる

電池の入れ方

1 カバーを開ける

2 単3形乾電池2本を入れる

3 カバーを閉じる

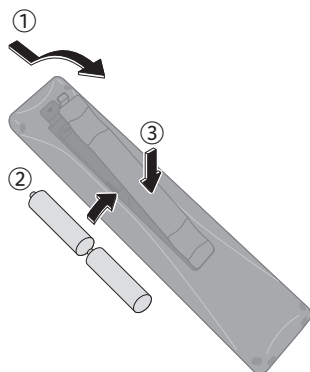

⚠ 乾電池に関するご注意

- 新しい電池と古い電池および種類の違う乾電池を混ぜて使わないでください。電池の破裂、液もれにより、火災・けがや周囲を汚損する原因となります。
- 長期間（1カ月以上）リモコンを使わないときは電池を取り出しておいてください。電池から液がもれて、火災・けが、周囲を汚損する原因となることがあります。
- 電池を機器内に挿入するときは、⊕ と ⊖ の向きに注意し、表示どおり入れてください。間違えると、電池の破裂、液もれにより、火災・けがや周囲を汚損する原因となることがあります。
- もし、液もれが起こったときは、ケース内の液を完全に拭き取ってから、新しい電池を入れてください。万一、もれた液が身体についたときは、水でよく洗い流してください。
- 不要となった電池を廃棄する場合は、各自自治体の指示（条例）に従ってください。
- 電池は加熱したり、分解したり、火や水の中に入れてたりしないでください。電池の破裂、液もれにより、火災やけがの原因となることがあります。
- 電池ケースに電池を挿入するときは、電池でマイナス端子を押し曲げないようにしてください。電池がショートし、液もれ、発熱の原因となります。

⚠ リモコン操作に関するご注意

- リモコンは、本機前面のリモコン受光部に向けて操作してください。操作できる範囲は受光部から7m、左右に30度以内です。
- 赤外線を発する機器の近くで本機を使用したり、赤外線を利用した機器のリモコン装置を使用すると、本機が誤動作することがあります。逆に、赤外線によってコントロールさせる他の機器を使用時に本機のリモコンを操作すると、その機器を誤動作させることがあります。
- 本機との間に障害物があったり、本機前面との角度が不適切だと、リモコン操作ができないことがあります。
- リモコンの操作可能範囲が極端に狭くなってきたら、電池を交換してください。
- リモコンのキー接点は、油脂の浸透や操作による摩擦で劣化します。特に食品や化粧品などの油分のついた手で操作しますと、寿命が短くなりますので注意してください。

各部の名称と働き

本機前面

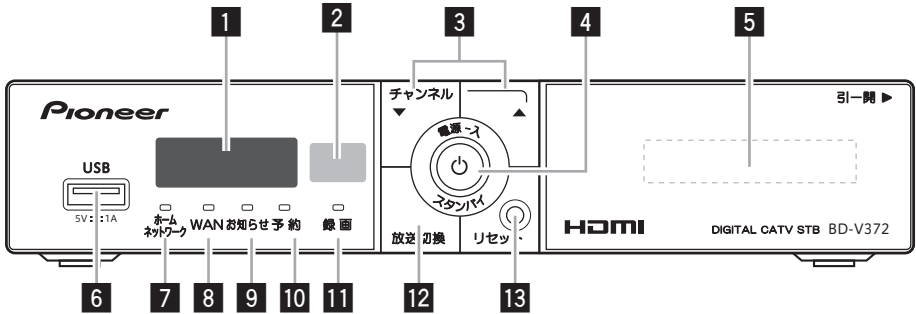

1. ディスプレイ

選んだチャンネル番号が表示されます。本機を20秒間操作しないと、輝度を落とします。スタンバイ時は消灯します。ケーブルテレビ局から送られてくる情報がある場合はメッセージを表示します。ディスプレイ拡張表示機能は、ご加入のケーブルテレビ局でサービスを提供している場合にご利用いただけます。

2. リモコン受光部

3. チャンネル切換ボタン

チャンネルを切り換えます。

4. 電源/スタンバイ (入/切) ボタン・電源インジケータ

緑：電源入時
橙：スタンバイ (通常モード)
通電制御を行っているときとスタンバイになっているときの2つのモードがあります。
赤：スタンバイ (省電力モード)

5. CASカード挿入口

6. USB端子

将来対応

7. ホームネットワークインジケータ

外部接続機器をLANケーブルで接続したとき、ネットワーク接続が確立している間は点灯します。

8. WANインジケータ

本機とWAN回線 (本機内蔵ケーブルモデム回線) に接続し、ネットワーク接続が確立している間は点灯します。

9. お知らせインジケータ

お知らせメッセージがあるときに点灯します。

10. 予約インジケータ

予約が登録されているときに点灯します。

11. 録画インジケータ

録画中に点灯します。

12. 放送切換ボタン

放送サービスを切り換えます。

13. リセットボタン (22ページ)

受信異常などで本機の操作ができなくなったときに、指で軽く押します。(先のとがったものは使わないでください。))

本機背面

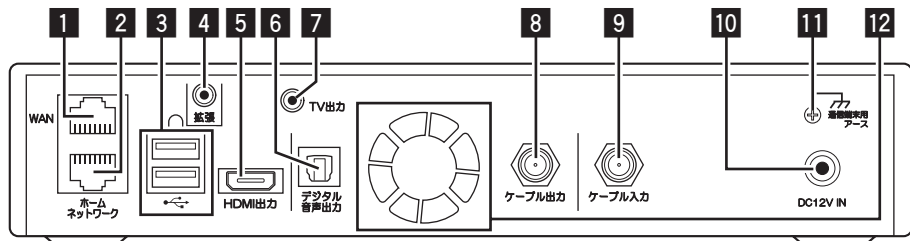

1. WAN 端子

インターネット回線などの10BASE-T/100BASE-TX 共用端子と接続します。

2. ホームネットワーク端子

外部機器などの10BASE-T/100BASE-TX 共用端子と接続します。

3. USB 端子

将来対応

4. 拡張端子

将来対応

5. HDMI 出力端子 (16 ページ)

HDMI(High-Definition Multimedia Interface) 対応テレビなどのHDMI 端子と接続します。

6. デジタル音声出力端子 (17 ページ)

デジタル音声の光出力端子です。使用するときには光角型端子用ケーブルで接続してください。

7. TV 出力端子 (15 ページ)

下図配線仕様の4 極ミニプラグビデオコードをご使用ください。

4 極ミニプラグ (映像 / 音声用)

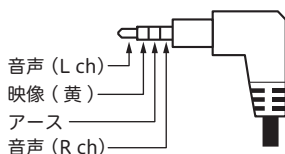

8. ケーブル出力端子 (18 ページ)

テレビまたはビデオのアンテナ入力端子と同軸ケーブル (75 Ω) で接続します。VHF 帯域およびUHF 帯域のチャンネルを出力します。

9. ケーブル入力端子

10. DC12V IN 端子

付属のACアダプターを差し込み、ご家庭のAC100 Vの電源コンセントに接続します。

11. 通信端末用アース端子

12. 冷却用ファン

⚠ 本機の電源について

- 電源を入れると、冷却のため本体内部の冷却ファンが回転します。
- 電源を切っても下記のようなときは内部の電源が入っているため、本体内部の冷却ファンが回転します。
 - 本機がCASカードの内容を確認しているときは、本体内部の電源が入った状態となります。

⚠ ご注意

- 本機は日本国内専用仕様 (交流 100 V) です。クーラー用などの200 Vコンセントには接続しないでください。また、船舶などの直流 (DC) 電源にも使えません。
- 本機の映像出力端子とテレビとの接続のしかたによって、映像が出力される端子が異なりますので、注意してください。詳しくは「テレビにつなぐ」(15 ページ)をご覧ください。

機器の接続

テレビにつなぐ

各機器を接続する前にお読みください。

- AV ケーブルなどのケーブル類は、電源プラグをコンセントに差し込む前に接続してください。
- 他の AV 機器の取扱説明書もあわせてお読みください。

| 接続方法 | テレビと接続する端子 | | 映像が出力される端子 | |
|-----------------|-------------|-----------|------------|---------|
| | ① HDMI 出力端子 | ② TV 出力端子 | HDMI 出力端子 | TV 出力端子 |
| ケース 1 ①のみで接続 | ● | - | ○ | × |
| ケース 2 ②のみで接続 | - | ● | × | ○ |
| ケース 3 ①と②で接続 | ● | ● | ○ | ○ |

- ：テレビと接続した端子 ○：映像が出力されます
-：テレビと接続していない端子 ×：映像が出力されません

- 音声出力および光デジタル出力は、映像が出力される端子にかかわらず出力されます。
- 他の AV 機器との接続に必要なケーブルは、別途お買い求めください。市販の HDMI ケーブルをお使いのときは、HDMI ロゴマークの付いた認定品をお使いください。
- 録画機器を経由してテレビへ接続しないでください。録画禁止放送のときに録画機器を仲介して接続すると、録画禁止信号（コピーガード信号）の影響により映像が乱れることがあります。
- DVI 端子付きテレビ（またはプロジェクターなど）に、本機の HDMI 出力端子を変換ケーブルなどを利用して接続したときは、映像が表示されないことがありますので注意してください。本機の HDMI 出力端子は HDMI 端子付きテレビにのみ接続してください。
- DVI 端子：DVI とは Digital Video Interface の略です。デジタル映像を直接伝送できる端子で、パソコンで主に利用されています。

テレビにつなぐ① — AV ケーブルでつなぐ

AV ケーブル(市販品)で接続します。

➡ は信号の流れる方向を示します。

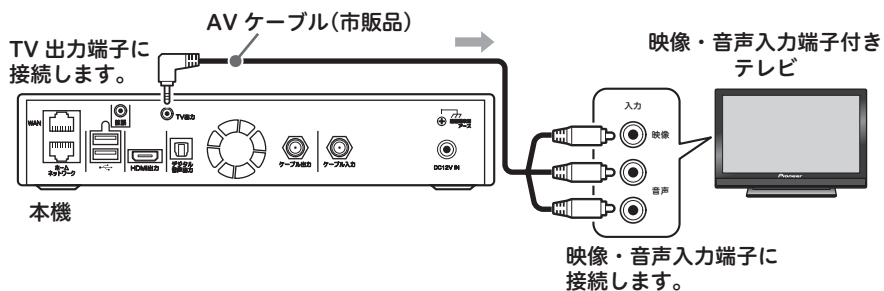

テレビにつなぐ② — HDMI ケーブルでつなぐ

HDMI ケーブル(市販品)で接続します。

➡ は信号の流れる方向を示します。

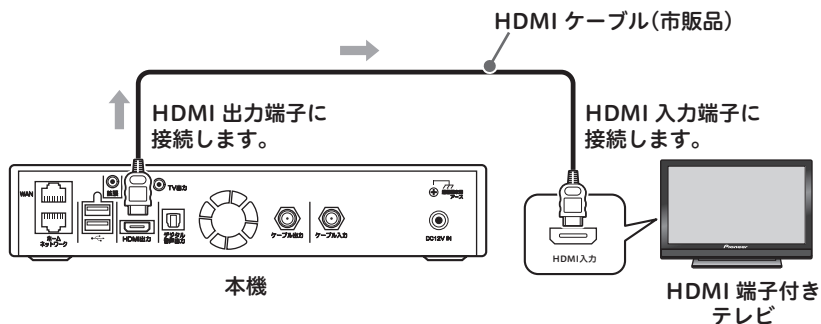

⚠️ ご注意

- HDCP というコンテンツ保護機能に対応していないテレビに接続したときは、番組の映像と音声は出力されません。このときは本機の TV 出力端子と接続してください。
- 3D 映像を視聴するときは、本機と 3D 対応テレビをハイスピード HDMI[®]/TM ケーブルで接続してください。
- 市販の HDMI ケーブルをお使いのときは、HDMI ロゴの付いた認定品をお使いください。

デジタル音声入力端子付きオーディオ機器につなぐ

光デジタルケーブル(市販品)で接続します。

➡ は信号の流れる方向を示します。

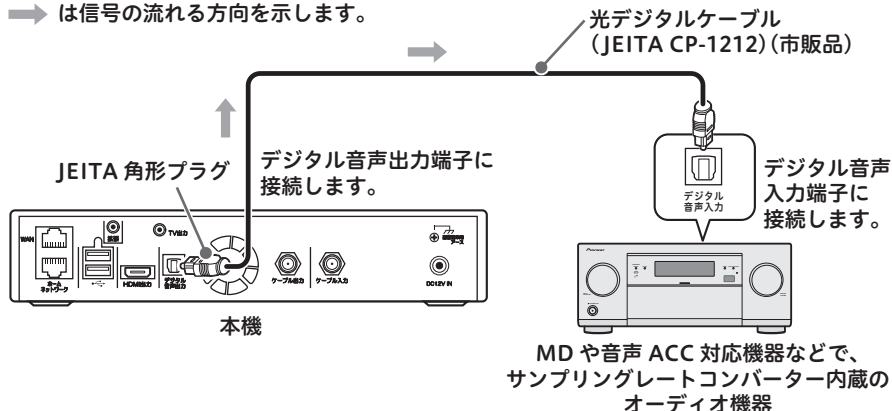

お知らせ

- 本機のデジタル音声出力端子はデジタル音声信号をそのまま出力していますので、送信されてくるサンプリング周波数に対応していないオーディオ機器は使えません。(送信されるサンプリング周波数には、32 kHz、44.1 kHz、48 kHz などがあり、サンプリングレートコンバーター内蔵のオーディオ機器が必要です。)

ホームネットワーク対応機器をつなぐ

ホームネットワーク機能をご加入のケーブルテレビ局でサービスを提供しているときにご利用いただけます。

ホームネットワークのみお使いになるとき

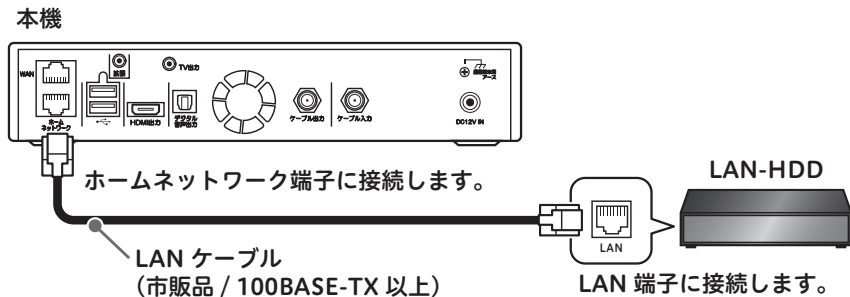

お知らせ

- ホームネットワーク接続が確立している間は、ホームネットワークインジケータが点灯します。

双方向で使用する

ホームネットワークと併用し、インターネットをCATV接続でお使いになるとき

インターネット接続の変更については、ご加入のケーブルテレビ局へお問い合わせください。

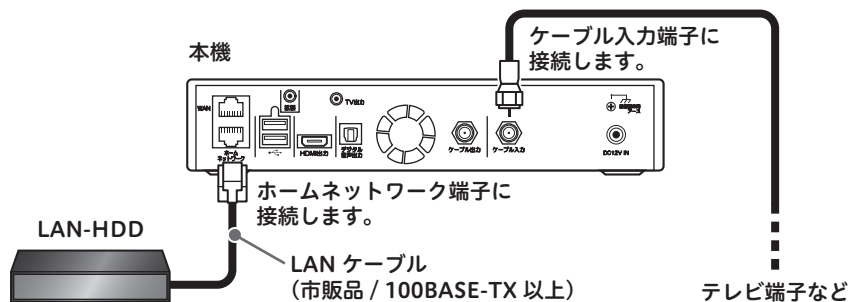

お知らせ

- ホームネットワーク接続が確立している間は、ホームネットワークインジケータが点灯します。
- CATV接続が確立している間は、WANインジケータが点灯します。

ホームネットワークと併用し、インターネットをWAN端子でお使いになるとき

インターネット接続の変更については、ご加入のケーブルテレビ局へお問い合わせください。

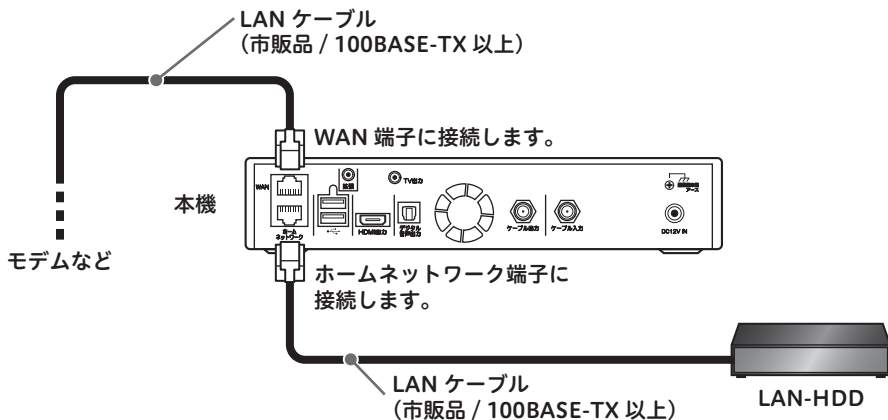

お知らせ

- ホームネットワーク接続が確立している間は、ホームネットワークインジケータが点灯します。
- WAN接続が確立している間は、WANインジケータが点灯します。

ホームネットワークと併用し、インターネットをホームネットワーク端子でお使いになるとき
インターネット接続の変更については、ご加入のケーブルテレビ局へお問い合わせください。

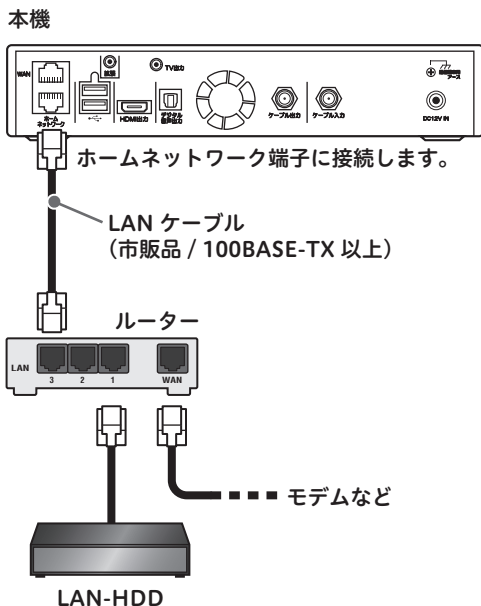

お知らせ

- ホームネットワーク接続が確立している間は、ホームネットワークインジケータが点灯します。

USB-HDD をつなぐ

1 台つないでお使いになるとき

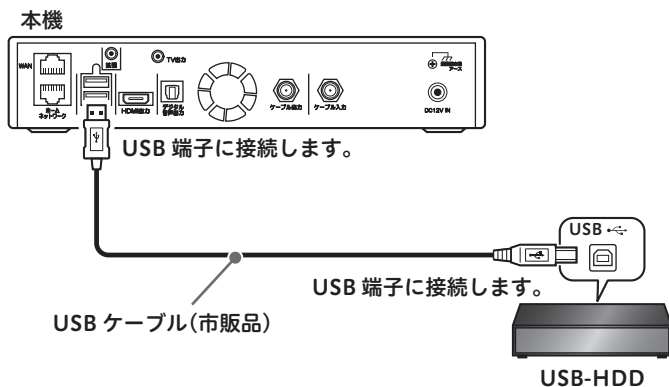

複数台つないでお使いになるとき

本機にはUSB-HDDを8台まで登録できます。そのうち3台まで同時に使用することができます。

USBハブを使ってUSB-HDDを3台接続する場合の例

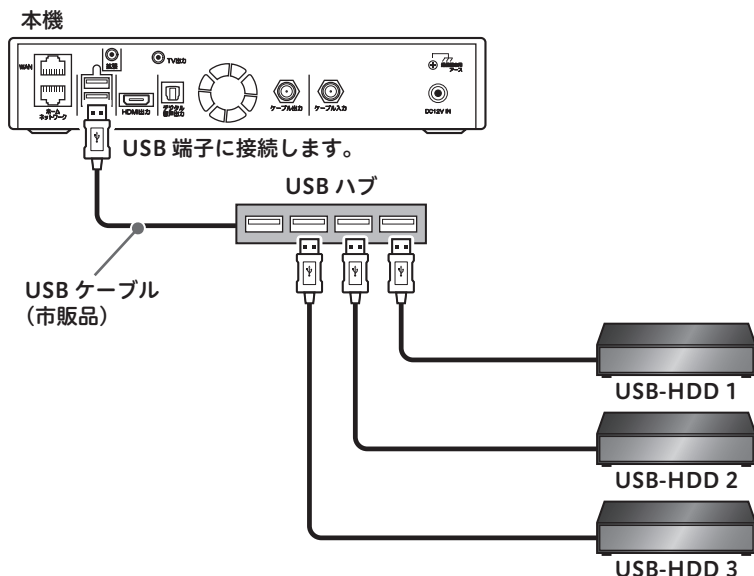

お知らせ

- 本機前面のUSB端子にも、USB-HDDやUSBハブを接続して使用することができます。
- 本機前面と背面のUSB端子に、同時にUSB-HDDやUSBハブを接続して使用することができます。

⚠ ご注意

- USB-HDDを接続するときは、本機の電源プラグをコンセントから抜いた状態のときに行ってください。
- 接続に使うケーブルは、USB-HDDに付属のケーブルをお使いください。
- 本機に接続できるのは、セルフパワー方式（ACアダプターあり）のUSB-HDDとなります。バスパワー方式（ACアダプターなし）のUSB-HDDには対応していません。
- USBハブを使って接続するときは、USBハブ（USB2.0以上）に専用のACアダプターを接続して、電源供給を行ってください。
- 複数のUSBハブを経由して、本機にUSB-HDDを接続することはできません。
- USB延長ケーブルで接続したときは、認識しないときがあります。
- USB-HDDの動作中は、本機の電源コードやUSBケーブルを抜いたりUSBハブおよびUSB-HDDの電源を切ったりしないでください。録画した内容が消えたり、USB-HDDの故障の原因となります。
- USB-HDDをお使いになるときは、USB-HDDの取扱説明書もあわせてお読みください。
- 本機に接続できるUSB-HDDについて詳しくは、ご加入のケーブルテレビ局にお問い合わせください。

付録

故障かな？と思ったら

修理を依頼する前にもう一度確認してください。

電源

| こんなとき | 確認してください | 参照ページ |
|---------|--|-------|
| 電源が入らない | <ul style="list-style-type: none">● ACアダプターの電源プラグはコンセントに正しく差し込まれていますか。 | 14 |

映像・音声

| こんなとき | 確認してください | 参照ページ |
|-------------------|--|----------|
| テレビの映像・音声が 出ない | <ul style="list-style-type: none">● テレビの電源プラグはコンセントに正しく差し込まれていますか。● テレビの電源は「入」になっていますか。● 本機の電源は「入」になっていますか。● 本機とテレビは正しく接続されていますか。 | 14、15、16 |

無線 LAN

| こんなとき | 確認してください | 参照ページ |
|---------------------------|--|-------|
| 無線 LAN 通信できない | <ul style="list-style-type: none">● 無線 LAN アダプターは正しく差し込まれていますか。● 電波の干渉により、通信がとぎれていませんか。 | 5、14 |
| アドホックモードで無線 LAN 通信できない | <ul style="list-style-type: none">● 本機と接続した機器がアドホックモードに対応していますか？ | 26 |

全指向性 R F リモコン

| こんなとき | 確認してください | 参照ページ |
|-------------------|---|-------|
| RF リモコンで動作 しない | <ul style="list-style-type: none">● リモコンの電池は正しく入っていますか。● リモコンの電池が消耗していませんか。● 電波の干渉により、通信がとぎれていませんか。 | 5 |

その他

| こんなとき | 確認してください | 参照ページ |
|-------------------------------|--|-------|
| 暗号化された放送、 有料放送の視聴が できない | <ul style="list-style-type: none">● 有料放送を視聴する契約はされていますか。● CAS カード (IC カード) は正しく挿入されていますか。 | 7、13 |
| 使用中に本体が熱くなる | <ul style="list-style-type: none">● 本機を使用中、使用環境によっては本体キャビネットの温度が若干高くなりますが、故障ではありません。 | — |
| 電源を「切」にしたのに動作音がする | <ul style="list-style-type: none">● ダウンロード、番組表情報取得、CAS カード (IC カード) 内の契約情報の更新などを実行しているときは、本体内部の電源が入っているため動作音 (冷却ファンの回転音) がします。 | — |

上記確認をしても動作が改善されないときは、本機前面のリセットボタンを押してください。(13 ページ)

本機が再起動し、「スタンバイ」の状態となります。電源ボタンまたはリモコンで電源を入れて確認してください。リセットボタンを押しても予約情報や各種設定は保持されます。

地上デジタル放送チャンネル一覧表

お住まいの地域別、地上デジタル放送のチャンネル一覧表です。
 ご加入のケーブルテレビ局により、チャンネル数と放送局名が異なる場合があります。
 ご加入のケーブルテレビ局にお問い合わせください。
 なお、地上デジタル放送が開始されていない地域では、予定されているチャンネル一覧になります。

| | | お住まいの地域 | | | | | | | | | | | | | | |
|------------|------------|-------------|------------|------------|------------|--------------|--------------|--------------|--------------|--------------|--------------|------------|-------------|------------|------------|------------|
| 放送局名 | 北海道(札幌) | 北海道(函館) | 北海道(旭川) | | | 北海道(帯広) | | | 北海道(釧路) | | | | | | | |
| | ① HBC札幌 | ① HBC函館 | ① HBC旭川 | ① HBC帯広 | ① HBC釧路 | ② NHK Eテレ・札幌 | ② NHK Eテレ・函館 | ② NHK Eテレ・旭川 | ② NHK Eテレ・帯広 | ② NHK Eテレ・釧路 | ③ NHK総合・札幌 | ③ NHK総合・函館 | ③ NHK総合・旭川 | ③ NHK総合・帯広 | ③ NHK総合・釧路 | |
| | ④ — | ④ — | ④ — | ④ — | ④ — | ⑤ STV札幌 | ⑤ STV函館 | ⑤ STV旭川 | ⑤ STV帯広 | ⑤ STV釧路 | ⑥ HTB札幌 | ⑥ HTB函館 | ⑥ HTB旭川 | ⑥ HTB帯広 | ⑥ HTB釧路 | |
| | ⑦ TVH札幌 | ⑦ TVH函館 | ⑦ TVH旭川 | ⑦ TVH帯広 | ⑦ TVH釧路 | ⑧ UHB札幌 | ⑧ UHB函館 | ⑧ UHB旭川 | ⑧ UHB帯広 | ⑧ UHB釧路 | ⑨ — | ⑨ — | ⑨ — | ⑨ — | ⑨ — | |
| | ⑩ — | ⑩ — | ⑩ — | ⑩ — | ⑩ — | ⑪ — | ⑪ — | ⑪ — | ⑪ — | ⑪ — | ⑫ — | ⑫ — | ⑫ — | ⑫ — | ⑫ — | |
| | ⑫ — | ⑫ — | ⑫ — | ⑫ — | ⑫ — | お住まいの地域 | | | | | | | | | | |
| | 放送局名 | 北海道(北見) | 北海道(室蘭) | 青森 | | | 岩手 | | | 宮城 | | | | | | |
| | | ① HBC北見 | ① HBC室蘭 | ① RAB青森放送 | ① NHK総合・盛岡 | ① TBCテレビ | ② NHK Eテレ・北見 | ② NHK Eテレ・室蘭 | ② NHK Eテレ・青森 | ② NHK Eテレ・盛岡 | ② NHK Eテレ・仙台 | ③ NHK総合・北見 | ③ NHK総合・室蘭 | ③ NHK総合・青森 | ③ — | ③ NHK総合・仙台 |
| | | ④ — | ④ — | ④ — | ④ — | ④ — | ⑤ STV北見 | ⑤ STV室蘭 | ⑤ 青森朝日放送 | ⑤ 岩手朝日テレビ | ⑤ KHB東日本放送 | ⑥ HTB北見 | ⑥ HTB室蘭 | ⑥ ATV青森テレビ | ⑥ IBCテレビ | ⑥ — |
| | | ⑦ TVH北見 | ⑦ TVH室蘭 | ⑦ — | ⑦ — | ⑦ — | ⑧ UHB北見 | ⑧ UHB室蘭 | ⑧ — | ⑧ めんこいテレビ | ⑧ 仙台放送 | ⑨ — | ⑨ — | ⑨ — | ⑨ — | ⑨ — |
| | | ⑩ — | ⑩ — | ⑩ — | ⑩ — | ⑩ — | ⑪ — | ⑪ — | ⑪ — | ⑪ — | ⑪ — | ⑫ — | ⑫ — | ⑫ — | ⑫ — | ⑫ — |
| | | ⑫ — | ⑫ — | ⑫ — | ⑫ — | ⑫ — | お住まいの地域 | | | | | | | | | |
| | | 放送局名 | 秋田 | 山形 | 福島 | | | 茨城 | | | 栃木 | | | | | |
| ① NHK総合・秋田 | | | ① NHK総合・山形 | ① NHK総合・福島 | ① NHK総合・水戸 | ① NHK総合・東京 | ② NHK Eテレ・秋田 | ② NHK Eテレ・山形 | ② NHK Eテレ・福島 | ② NHK Eテレ・東京 | ② NHK Eテレ・東京 | ③ — | ③ — | ③ — | ③ — | ③ — |
| ④ ABS秋田放送 | | | ④ YBC山形放送 | ④ 福島中央テレビ | ④ 日本テレビ | ④ 日本テレビ | ⑤ AAB秋田朝日放送 | ⑤ YTS山形テレビ | ⑤ KFB福島放送 | ⑤ テレビ朝日 | ⑤ テレビ朝日 | ⑥ — | ⑥ — | ⑥ — | ⑥ — | ⑥ — |
| ⑦ — | | | ⑦ テレビユー山形 | ⑦ テレビユー福島 | ⑦ TBS | ⑦ TBS | ⑧ AKT秋田テレビ | ⑧ さくらんぼテレビ | ⑧ 福島テレビ | ⑧ ファジテレビジョン | ⑧ ファジテレビジョン | ⑨ — | ⑨ — | ⑨ — | ⑨ — | ⑨ — |
| ⑩ — | | | ⑩ — | ⑩ — | ⑩ — | ⑩ — | ⑪ — | ⑪ — | ⑪ — | ⑪ — | ⑪ — | ⑫ — | ⑫ — | ⑫ — | ⑫ — | ⑫ — |
| ⑫ — | | | ⑫ — | ⑫ — | ⑫ — | ⑫ — | お住まいの地域 | | | | | | | | | |
| 放送局名 | | | 群馬 | 埼玉 | 千葉 | | | 東京 | | | 神奈川 | | | | | |
| | ① NHK総合・東京 | | ① NHK総合・東京 | ① NHK総合・東京 | ① NHK総合・東京 | ① NHK総合・東京 | ② NHK Eテレ・東京 | ② NHK Eテレ・東京 | ② NHK Eテレ・東京 | ② NHK Eテレ・東京 | ② NHK Eテレ・東京 | ③ 群馬テレビ | ③ テレビ玉 | ③ チバテレビ | ③ — | ③ — |
| | ④ 日本テレビ | | ④ 日本テレビ | ④ 日本テレビ | ④ 日本テレビ | ④ 日本テレビ | ⑤ テレビ朝日 | ⑤ テレビ朝日 | ⑤ テレビ朝日 | ⑤ テレビ朝日 | ⑤ テレビ朝日 | ⑥ TBS | ⑥ TBS | ⑥ TBS | ⑥ TBS | ⑥ TBS |
| | ⑦ テレビ東京 | | ⑦ テレビ東京 | ⑦ テレビ東京 | ⑦ テレビ東京 | ⑦ テレビ東京 | ⑧ ファジテレビジョン | ⑧ ファジテレビジョン | ⑧ ファジテレビジョン | ⑧ ファジテレビジョン | ⑧ ファジテレビジョン | ⑨ — | ⑨ — | ⑨ — | ⑨ — | ⑨ — |
| | ⑩ — | | ⑩ — | ⑩ — | ⑩ — | ⑩ — | ⑪ — | ⑪ — | ⑪ — | ⑪ — | ⑪ — | ⑫ — | ⑫ — | ⑫ — | ⑫ — | ⑫ — |
| | ⑫ — | | ⑫ — | ⑫ — | ⑫ — | ⑫ — | お住まいの地域 | | | | | | | | | |
| | 放送局名 | | 新潟 | 富山 | 石川 | | | 福井 | | | 山梨 | | | | | |
| | | ① NHK総合・新潟 | ① KNB北日本放送 | ① NHK総合・金沢 | ① NHK総合・福井 | ① NHK総合・甲府 | ② NHK Eテレ・新潟 | ② NHK Eテレ・富山 | ② NHK Eテレ・金沢 | ② NHK Eテレ・福井 | ② NHK Eテレ・甲府 | ③ 群馬テレビ | ③ NHK総合・富山 | ③ — | ③ — | ③ — |
| | | ④ TeNYテレビ新潟 | ④ — | ④ テレビ金沢 | ④ — | ④ — | ⑤ 新潟テレビ21 | ⑤ — | ⑤ 北陸朝日放送 | ⑤ — | ⑤ — | ⑥ BSN | ⑥ チューリップテレビ | ⑥ MRO | ⑥ — | ⑥ UTY |
| | | ⑦ — | ⑦ — | ⑦ — | ⑦ FBCテレビ | ⑦ — | ⑧ NST | ⑧ BBT富山テレビ | ⑧ 石川テレビ | ⑧ 福井テレビ | ⑧ — | ⑨ — | ⑨ — | ⑨ — | ⑨ — | ⑨ — |
| | | ⑩ — | ⑩ — | ⑩ — | ⑩ — | ⑩ — | ⑪ — | ⑪ — | ⑪ — | ⑪ — | ⑪ — | ⑫ — | ⑫ — | ⑫ — | ⑫ — | ⑫ — |
| | | ⑫ — | ⑫ — | ⑫ — | ⑫ — | ⑫ — | お住まいの地域 | | | | | | | | | |

| | | お住まいの地域 | | | | | | | | | |
|------|-----|-----------------|-----|-------------|----|------------|----|-------------|----|-------------|--|
| 放送局名 | 長野 | | 岐阜 | | 静岡 | | 愛知 | | 三重 | | |
| | ① | NHK総合・長野 | ① | 東海テレビ | ① | NHK総合・静岡 | ① | 東海テレビ | ① | 東海テレビ | |
| | ② | NHK Eテレ・長野 | ② | NHK Eテレ・名古屋 | ② | NHK Eテレ・静岡 | ② | NHK Eテレ・名古屋 | ② | NHK Eテレ・名古屋 | |
| | ③ | — | ③ | NHK総合・岐阜 | ③ | — | ③ | NHK総合・名古屋 | ③ | NHK総合・津 | |
| | ④ | テレビ信州 | ④ | 中京テレビ | ④ | 静岡第一テレビ | ④ | 中京テレビ | ④ | 中京テレビ | |
| | ⑤ | abn長野朝日放送 | ⑤ | CBC | ⑤ | 静岡朝日テレビ | ⑤ | CBC | ⑤ | CBC | |
| | ⑥ | SBC信越放送 | ⑥ | メ〜テレ | ⑥ | SBS | ⑥ | メ〜テレ | ⑥ | メ〜テレ | |
| | ⑦ | — | ⑦ | — | ⑦ | — | ⑦ | — | ⑦ | 三重テレビ | |
| | ⑧ | NBS長野放送 | ⑧ | 岐阜テレビ | ⑧ | テレビ静岡 | ⑧ | — | ⑧ | — | |
| | ⑨ | — | ⑨ | — | ⑨ | — | ⑨ | — | ⑨ | — | |
| | ⑩ | — | ⑩ | — | ⑩ | — | ⑩ | テレビ愛知 | ⑩ | — | |
| | ⑪ | — | ⑪ | — | ⑪ | — | ⑪ | — | ⑪ | — | |
| | ⑫ | — | ⑫ | — | ⑫ | — | ⑫ | — | ⑫ | — | |
| | | お住まいの地域 | | | | | | | | | |
| 放送局名 | 滋賀 | | 京都 | | 大阪 | | 兵庫 | | 奈良 | | |
| | ① | NHK総合・大津 | ① | NHK総合・京都 | ① | NHK総合・大阪 | ① | NHK総合・神戸 | ① | NHK総合・奈良 | |
| | ② | NHK Eテレ・大津 | ② | NHK Eテレ・大阪 | ② | NHK Eテレ・大阪 | ② | NHK Eテレ・大阪 | ② | NHK Eテレ・大阪 | |
| | ③ | BBCびわ湖放送 | ③ | — | ③ | — | ③ | サンテレビ | ③ | — | |
| | ④ | MBS毎日放送 | ④ | MBS毎日放送 | ④ | MBS毎日放送 | ④ | MBS毎日放送 | ④ | MBS毎日放送 | |
| | ⑤ | — | ⑤ | KBS京都 | ⑤ | — | ⑤ | — | ⑤ | — | |
| | ⑥ | ABCテレビ | ⑥ | ABCテレビ | ⑥ | ABCテレビ | ⑥ | ABCテレビ | ⑥ | ABCテレビ | |
| | ⑦ | — | ⑦ | — | ⑦ | テレビ大阪 | ⑦ | — | ⑦ | — | |
| | ⑧ | 関西テレビ | ⑧ | 関西テレビ | ⑧ | 関西テレビ | ⑧ | 関西テレビ | ⑧ | 関西テレビ | |
| | ⑨ | — | ⑨ | — | ⑨ | — | ⑨ | — | ⑨ | 奈良テレビ | |
| | ⑩ | 読売テレビ | ⑩ | 読売テレビ | ⑩ | 読売テレビ | ⑩ | 読売テレビ | ⑩ | 読売テレビ | |
| | ⑪ | — | ⑪ | — | ⑪ | — | ⑪ | — | ⑪ | — | |
| | ⑫ | — | ⑫ | — | ⑫ | — | ⑫ | — | ⑫ | — | |
| | | お住まいの地域 | | | | | | | | | |
| 放送局名 | 和歌山 | | 鳥取 | | 島根 | | 岡山 | | 広島 | | |
| | ① | NHK総合・和歌山 | ① | 日本海テレビ | ① | 日本海テレビ | ① | NHK総合・岡山 | ① | NHK総合・広島 | |
| | ② | NHK Eテレ・和歌山 | ② | NHK Eテレ・鳥取 | ② | NHK Eテレ・松江 | ② | NHK Eテレ・岡山 | ② | NHK Eテレ・広島 | |
| | ③ | — | ③ | NHK総合・鳥取 | ③ | NHK総合・松江 | ③ | — | ③ | RCCテレビ | |
| | ④ | MBS毎日放送 | ④ | — | ④ | — | ④ | RNC西日本テレビ | ④ | 広島テレビ | |
| | ⑤ | テレビ和歌山 | ⑤ | — | ⑤ | — | ⑤ | KSB瀬戸内海放送 | ⑤ | 広島ホームテレビ | |
| | ⑥ | ABCテレビ | ⑥ | BSSテレビ | ⑥ | BSSテレビ | ⑥ | RSKテレビ | ⑥ | — | |
| | ⑦ | — | ⑦ | — | ⑦ | — | ⑦ | テレビせとうち | ⑦ | — | |
| | ⑧ | 関西テレビ | ⑧ | 山陰中央テレビ | ⑧ | 山陰中央テレビ | ⑧ | OHKテレビ | ⑧ | TSS | |
| | ⑨ | — | ⑨ | — | ⑨ | — | ⑨ | — | ⑨ | — | |
| | ⑩ | 読売テレビ | ⑩ | — | ⑩ | — | ⑩ | — | ⑩ | — | |
| | ⑪ | — | ⑪ | — | ⑪ | — | ⑪ | — | ⑪ | — | |
| | ⑫ | — | ⑫ | — | ⑫ | — | ⑫ | — | ⑫ | — | |
| | | お住まいの地域 | | | | | | | | | |
| 放送局名 | 山口 | | 徳島 | | 香川 | | 愛媛 | | 高知 | | |
| | ① | NHK総合・山口 | ① | 四国放送 | ① | NHK総合・高松 | ① | NHK総合・松山 | ① | NHK総合・高知 | |
| | ② | NHK Eテレ・山口 | ② | NHK Eテレ・徳島 | ② | NHK Eテレ・高松 | ② | NHK Eテレ・松山 | ② | NHK Eテレ・高知 | |
| | ③ | TVSテレビ山口 | ③ | NHK総合・徳島 | ③ | — | ③ | — | ③ | — | |
| | ④ | KRY山口放送 | ④ | — | ④ | RNC西日本テレビ | ④ | 南海放送 | ④ | 高知放送 | |
| | ⑤ | YAB山口朝日 | ⑤ | — | ⑤ | KSB瀬戸内海放送 | ⑤ | 愛媛朝日 | ⑤ | — | |
| | ⑥ | — | ⑥ | — | ⑥ | RSKテレビ | ⑥ | あいテレビ | ⑥ | テレビ高知 | |
| | ⑦ | — | ⑦ | — | ⑦ | テレビせとうち | ⑦ | — | ⑦ | — | |
| | ⑧ | — | ⑧ | — | ⑧ | OHKテレビ | ⑧ | テレビ愛媛 | ⑧ | さんさんテレビ | |
| | ⑨ | — | ⑨ | — | ⑨ | — | ⑨ | — | ⑨ | — | |
| | ⑩ | — | ⑩ | — | ⑩ | — | ⑩ | — | ⑩ | — | |
| | ⑪ | — | ⑪ | — | ⑪ | — | ⑪ | — | ⑪ | — | |
| | ⑫ | — | ⑫ | — | ⑫ | — | ⑫ | — | ⑫ | — | |
| | | お住まいの地域 | | | | | | | | | |
| 放送局名 | 福岡 | | 佐賀 | | 長崎 | | 熊本 | | 大分 | | |
| | ① | KBC九州朝日放送 | ① | NHK総合・佐賀 | ① | NHK総合・長崎 | ① | NHK総合・熊本 | ① | NHK総合・大分 | |
| | ② | NHK Eテレ・福岡(北九州) | ② | NHK Eテレ・佐賀 | ② | NHK Eテレ・長崎 | ② | NHK Eテレ・熊本 | ② | NHK Eテレ・大分 | |
| | ③ | NHK総合・福岡(北九州) | ③ | STSサガテレビ | ③ | NBC長崎放送 | ③ | RKK熊本放送 | ③ | OBS大分放送 | |
| | ④ | RKB毎日放送 | ④ | — | ④ | NIB長崎国際テレビ | ④ | KKTくまもと県民 | ④ | TOSテレビ大分 | |
| | ⑤ | FBS福岡放送 | ⑤ | — | ⑤ | NCC長崎文化放送 | ⑤ | KAB熊本朝日放送 | ⑤ | OAB大分朝日放送 | |
| | ⑥ | — | ⑥ | — | ⑥ | — | ⑥ | — | ⑥ | — | |
| | ⑦ | TVQ九州放送 | ⑦ | — | ⑦ | — | ⑦ | — | ⑦ | — | |
| | ⑧ | TNCテレビ西日本 | ⑧ | — | ⑧ | KTNテレビ長崎 | ⑧ | TKUテレビ熊本 | ⑧ | — | |
| | ⑨ | — | ⑨ | — | ⑨ | — | ⑨ | — | ⑨ | — | |
| | ⑩ | — | ⑩ | — | ⑩ | — | ⑩ | — | ⑩ | — | |
| | ⑪ | — | ⑪ | — | ⑪ | — | ⑪ | — | ⑪ | — | |
| | ⑫ | — | ⑫ | — | ⑫ | — | ⑫ | — | ⑫ | — | |
| | | お住まいの地域 | | | | | | | | | |
| 放送局名 | 宮崎 | | 鹿児島 | | 沖縄 | | | | | | |
| | ① | NHK総合・宮崎 | ① | MBC南日本放送 | ① | NHK総合・那覇 | | | | | |
| | ② | NHK Eテレ・宮崎 | ② | NHK Eテレ・鹿児島 | ② | NHK Eテレ・那覇 | | | | | |
| | ③ | UMKテレビ宮崎 | ③ | NHK総合・鹿児島 | ③ | RBCテレビ | | | | | |
| | ④ | — | ④ | KYT鹿児島読売TV | ④ | — | | | | | |
| | ⑤ | — | ⑤ | KKB鹿児島放送 | ⑤ | QAB琉球朝日放送 | | | | | |
| | ⑥ | MRT宮崎放送 | ⑥ | — | ⑥ | — | | | | | |
| | ⑦ | — | ⑦ | — | ⑦ | — | | | | | |
| | ⑧ | — | ⑧ | KTS鹿児島テレビ | ⑧ | 沖縄テレビ(OTV) | | | | | |
| | ⑨ | — | ⑨ | — | ⑨ | — | | | | | |
| | ⑩ | — | ⑩ | — | ⑩ | — | | | | | |
| | ⑪ | — | ⑪ | — | ⑪ | — | | | | | |
| | ⑫ | — | ⑫ | — | ⑫ | — | | | | | |

(2014年3月現在)

仕様

本機の仕様

受信仕様

| | |
|------------------------|-------------------------------------|
| BS デジタル放送受信 | |
| 110 度 CS デジタル放送受信 | |
| 地上デジタル放送トランスモジュレーション受信 | |
| 地上デジタル放送パススルー受信 | |
| JC-HITS 放送受信 | |
| CATV 放送受信 | |
| 受信周波数範囲 | 90 MHz ~ 1 GHz |
| 入力信号レベル | |
| | 49 dB μ V ~ 81 dB μ V (平均値) |

入出力端子

| | |
|-----------------------|-----------------------------|
| ケーブル入力信号分配数 | 1 |
| ケーブル出力 | |
| | - 5 dB (76 MHz ~ 770 MHz) |
| | - 6 dB (770 MHz ~ 1 GHz) |
| | (入力信号に対して) |
| TV 出力端子 | 1 系統 |
| 映像出力レベル | 1.0 V [p-p]、75 Ω |
| 音声出力レベル | 250 mV [rms]、2.2 k Ω |
| デジタル音声出力端子 | 1 系統 |
| デジタル音声出力レベル | 660 nm JEITA CP-1212 に準拠 |
| B-CAS カードスロット | 1 |
| C-CAS カードスロット | 1 |
| LAN 接続端子 | 2 系統 |
| (10BASE-T/100BASE-TX) | |
| USB 端子 | |
| リア | 2 系統 |
| フロント | 1 系統 |
| HDMI 出力端子 | 1 系統 |

RF 送信仕様

| | |
|-----------|--------------------------------|
| 送信周波数範囲 | 10 MHz ~ 55 MHz |
| 出力レベル可変範囲 | |
| | 68 dB μ V ~ 118 dB μ V |

電源部

| | |
|------------------|---------------------|
| AC アダプター (付属品) | |
| AC 入力 | AC100 V、50 Hz/60 Hz |
| DC 出力 | 12 V |
| 本体 | |
| DC 入力 | 12 V |
| | (付属の AC アダプターを使用) |
| 消費電力 | |
| 電源入時 | 22 W |
| 待機時消費電力 | |
| (スタンバイ時: 通常モード) | 21 W |
| 待機時消費電力 | |
| (スタンバイ時: 省電力モード) | 0.3 W |

外形寸法

| | |
|---------|-------------------------|
| 幅×高さ×奥行 | |
| | 225 mm × 48 mm × 182 mm |
| 質量 | 約 1.2 kg |

付属品

| | |
|------------|---|
| リモコン | 1 |
| AC アダプター | 1 |
| 単 3 形乾電池 | 2 |
| 電源コード | |
| 取扱説明書 (本書) | |

無線 LAN アダプターの仕様

| | | |
|--------------------|---|--|
| 無線 LAN インターフェース | 準拠規格 | ARIB STD-T71 (5 GHz) ARIB STD-T66 (2.4 GHz) 小電力データ通信システム規格 無線 LAN 標準プロトコル IEEE802.11a/IEEE802.11b/IEEE802.11g/IEEE802.11n |
| | 伝送方式 | 多入力多出力直交周波数分割多重変調 (MIMO-OFDM) 方式 直交周波数分割多重変調 (OFDM) 方式 直接拡散型スペクトラム拡散 (DS-SS) 方式 単信 (半二重) |
| | データ伝送速度 (理論値) | IEEE 802.11a (最大 54Mbps) IEEE 802.11b (最大 11Mbps) IEEE 802.11g (最大 54Mbps) IEEE 802.11n (最大 300Mbps) |
| | 周波数範囲 (中心周波数) | IEEE802.11a/n: W52 36 ch,40 ch,44 ch,48 ch(5180 MHz ~ 5240 MHz) W53 52 ch,56 ch,60 ch,64 ch(5260 MHz ~ 5320 MHz) W56 100 ch,104 ch,108 ch,112 ch,116 ch,120 ch,124 ch, 128 ch,132 ch,136 ch,140 ch(5500 MHz ~ 5700MHz) IEEE 802.11b/g/n: 1 ch ~ 13 ch(2412 MHz ~ 2472 MHz) |
| | アクセス方式 | インフラストラクチャモード、アドホックモード |
| セキュリティ | WPA-PSK(TKIP/AES)、WPA2-PSK(TKIP/AES)、WEP (128 bit/64 bit) | |
| 接続 インターフェース | USB 端子 (A type) | USB 2.0 |
| 一般 | 外形 (幅 × 高さ × 奥行) | 66.4 mm × 20 mm × 9.8 mm |
| | 質量 | 約 11 g |
| | 使用周囲温度 範囲 | + 5 °C ~ + 40 °C |
| | 電源電圧 | DC + 5 V (USB 電源供給) |

Web ブラウザの仕様

仕様

- HTML 4.01 (XHTML1.1)
- Java Script 1.5 サブセット DOM level 1、DOM level 2 の一部
- HTTP 1.1
- SSL Ver.2/Ver.3 TLS v1.0
- かな漢字変換 : ASK

コンテンツ

- Image : GIF、アニメーション GIF、JPEG、プログレッシブ JPEG、PNG
- Text : text、HTML
- Sound : AIFF、MPEG-AAC、WAV
- Single plane Graphics

- * 仕様および外観は、改善のため予告なく変更することがありますのでご了承ください。
- * ケーブル局の運用により動作する機能が異なる場合がありますので、詳しくはご加入のケーブルテレビ局にお問い合わせください。
- * 日本ケーブルラボの各仕様に準拠
 - BS デジタル放送トランスモジュレーション運用仕様 (JLabs SPEC-001)
 - 東経 110 度 CS デジタル放送トランスモジュレーション運用仕様 (JLabs SPEC-002)
 - デジタル放送リマックス運用仕様 (自主放送) (JLabs SPEC-003)
 - デジタル放送リマックス運用仕様 (i-HITS) (JLabs SPEC-004)
 - JC-HITS トランスモジュレーション運用仕様 (JLabs SPEC-005)
 - 地上デジタルテレビジョン放送パススルー運用仕様 (JLabs SPEC-006)
 - 地上デジタルテレビジョン放送トランスモジュレーション運用仕様 (JLabs SPEC-007)
 - デジタル放送高度リマックス運用仕様 (自主放送) (JLabs SPEC-017)
 - デジタル放送高度リマックス運用仕様 (i-HITS) (JLabs SPEC-018)
 - デジタル放送高度 JC-HITS トランスモジュレーション運用仕様 (JLabs SPEC-019)
 - デジタルケーブルテレビ双方向運用仕様 (JLabs SPEC-011)
 - ケーブル DLNA 運用仕様 (JLabs SPEC-020)
 - 次世代 STB 技術仕様 (JLabs SPEC-023)
- * デジタル有線テレビジョン放送受信装置標準規格 (JCTEA STD-007)

ライセンス

ここでは、本機に使われているソフトウェアの利用許諾（ライセンス）について記載しています。正確な内容を保持するため、原文（英語）を記載しています。

[JPEG image compression]

If only executable code is distributed, then the accompanying documentation must state that "this software is based in part on the work of the Independent JPEG Group".

[libpng]

COPYRIGHT NOTICE, DISCLAIMER, and LICENSE:

If you modify libpng you may insert additional notices immediately following this sentence. libpng versions 1.2.6, August 15, 2004, through 1.2.25, February 18, 2008, are Copyright © 2004, 2006-2008 Glenn Randers-Pehrson, and are distributed according to the same disclaimer and license as libpng-1.2.5 with the following individual added to the list of Contributing Authors

Cosmin Truta

libpng versions 1.0.7, July 1, 2000, through 1.2.5 - October 3, 2002, are Copyright © 2000-2002 Glenn Randers-Pehrson, and are distributed according to the same disclaimer and license as libpng-1.0.6 with the following individuals added to the list of Contributing Authors

Simon-Pierre Cadieux

Eric S. Raymond

Gilles Vollant

and with the following additions to the disclaimer:

There is no warranty against interference with your enjoyment of the library or against infringement. There is no warranty that our efforts or the library will fulfill any of your particular purposes or needs. This library is provided with all faults, and the entire risk of satisfactory quality, performance, accuracy, and effort is with the user. libpng versions 0.97, January 1998, through 1.0.6, March 20, 2000, are Copyright © 1998, 1999 Glenn Randers-Pehrson, and are distributed according to the same disclaimer and license as libpng-0.96, with the following individuals added to the list of Contributing Authors:

Tom Lane

Glenn Randers-Pehrson

Willem van Schaik

libpng versions 0.89, June 1996, through 0.96, May 1997, are Copyright © 1996, 1997 Andreas Dilger Distributed according to the same disclaimer and license as libpng-0.88, with the following individuals added to the list of Contributing Authors:

John Bowler

Kevin Bracey

Sam Bushell

Magnus Holmgren

Greg Roelofs

Tom Tanner

libpng versions 0.5, May 1995, through 0.88, January 1996, are Copyright © 1995, 1996 Guy Eric Schalnat, Group 42, Inc. For the purposes of this copyright and license, "Contributing Authors" is defined as the following set of individuals:

Andreas Dilger

Dave Martindale

Guy Eric Schalnat

Paul Schmidt

Tim Wegner

The PNG Reference Library is supplied "AS IS". The Contributing Authors and Group 42, Inc. disclaim all warranties, expressed or implied, including, without limitation, the warranties of merchantability and of fitness for any purpose. The Contributing Authors and Group 42, Inc. assume no liability for direct, indirect, incidental, special, exemplary, or consequential damages, which may result from the use of the PNG Reference Library, even if advised of the possibility of such damage.

Permission is hereby granted to use, copy, modify, and distribute this source code, or portions hereof, for any purpose, without fee, subject to the following restrictions:

1. The origin of this source code must not be misrepresented.
2. Altered versions must be plainly marked as such and must not be misrepresented as being the original source.
3. This Copyright notice may not be removed or altered from any source or altered source distribution.

The Contributing Authors and Group 42, Inc. specifically permit, without fee, and encourage the use of this source code as a component to supporting the PNG file format in commercial products. If you use this source code in a product,

acknowledgment is not required but would be appreciated.

A "png_get_copyright" function is available, for convenient use in "about" boxes and the like: `printf("%s", png_get_copyright(NULL));` Also, the PNG logo (in PNG format, of course) is supplied in the files "pngbar.png" and "pngbar.jpg" (88x31) and "pngnow.png" (98x31). Libpng is OSI Certified Open Source Software. OSI Certified Open Source is a certification mark of the Open Source Initiative.

Glenn Randers-Pehrson

glennrp at users.sourceforge.net

February 18, 2008

[zlib]

This software is based in part on zlib see <http://www.zlib.net> for information.

This software is provided "as-is", without any express or implied warranty. In no event will the authors be held liable for any damages arising from the use of this software.

Permission is granted to anyone to use this software for any purpose, including commercial applications, and to alter it and redistribute it freely, subject to the following restrictions:

1. The origin of this software must not be misrepresented; you must not claim that you wrote the original software. If you use this software in a product, an acknowledgment in the product documentation would be appreciated but is not required.
2. Altered source versions must be plainly marked as such, and must not be misrepresented as being the original source.
3. This notice may not be removed or altered from any source distribution.

[OpenSSL License]

Copyright (c) 1998-2008 The OpenSSL Project. All rights reserved.

Redistribution and use in source and binary forms, with or without modification, are permitted provided that the following conditions are met:

1. Redistributions of source code must retain the above copyright notice, this list of conditions and the following disclaimer.
2. Redistributions in binary form must reproduce the above copyright notice, this list of conditions and the following disclaimer in the documentation and/or other materials provided with the distribution.
3. All advertising materials mentioning features or use of this software must display the following acknowledgment:
"This product includes software developed by the OpenSSL Project for use in the OpenSSL Toolkit. (<http://www.openssl.org/>)"
4. The names "OpenSSL Toolkit" and "OpenSSL Project" must not be used to endorse or promote products derived from this software without prior written permission. For written permission, please contact openssl-core@openssl.org.
5. Products derived from this software may not be called "OpenSSL" nor may "OpenSSL" appear in their names without prior written permission of the OpenSSL Project.
6. Redistributions of any form whatsoever must retain the following acknowledgment:
"This product includes software developed by the OpenSSL Project for use in the OpenSSL Toolkit (<http://www.openssl.org/>)"

THIS SOFTWARE IS PROVIDED BY THE OPENSSL PROJECT "AS IS" AND ANY EXPRESSED OR IMPLIED WARRANTIES, INCLUDING, BUT NOT LIMITED TO, THE IMPLIED WARRANTIES OF MERCHANTABILITY AND FITNESS FOR A PARTICULAR PURPOSE ARE DISCLAIMED. IN NO EVENT SHALL THE OPENSSL PROJECT OR ITS CONTRIBUTORS BE LIABLE FOR ANY DIRECT, INDIRECT, INCIDENTAL, SPECIAL, EXEMPLARY, OR CONSEQUENTIAL DAMAGES (INCLUDING, BUT NOT LIMITED TO, PROCUREMENT OF SUBSTITUTE GOODS OR SERVICES; LOSS OF USE, DATA, OR PROFITS; OR BUSINESS INTERRUPTION) HOWEVER CAUSED AND ON ANY THEORY OF LIABILITY, WHETHER IN CONTRACT, STRICT LIABILITY, OR TORT (INCLUDING NEGLIGENCE OR OTHERWISE) ARISING IN ANY WAY OUT OF THE USE OF THIS SOFTWARE, EVEN IF ADVISED OF THE POSSIBILITY OF SUCH DAMAGE.

This product includes cryptographic software written by Eric

Young (eay@cryptsoft.com). This product includes software written by Tim Hudson (tjh@cryptsoft.com).

[Original SSLeay License]

Copyright (C) 1995-1998 Eric Young (eay@cryptsoft.com)
All rights reserved.
This package is an SSL implementation written by Eric Young (eay@cryptsoft.com).
The implementation was written so as to conform with Netscapes SSL.

This library is free for commercial and non-commercial use as long as the following conditions are aheared to. The following conditions apply to all code found in this distribution, be it the RC4, RSA, Ihash, DES, etc., code; not just the SSL code. The SSL documentation included with this distribution is covered by the same copyright terms except that the holder is Tim Hudson (tjh@cryptsoft.com).

Copyright remains Eric Young's, and as such any Copyright notices in the code are not to be removed.
If this package is used in a product, Eric Young should be given attribution as the author of the parts of the library used.
This can be in the form of a textual message at program startup or in documentation (online or textual) provided with the package.

Redistribution and use in source and binary forms, with or without modification, are permitted provided that the following conditions are met:

1. Redistributions of source code must retain the copyright notice, this list of conditions and the following disclaimer.
2. Redistributions in binary form must reproduce the above copyright notice, this list of conditions and the following disclaimer in the documentation and/or other materials provided with the distribution.
3. All advertising materials mentioning features or use of this software must display the following acknowledgement:
"This product includes cryptographic software written by Eric Young (eay@cryptsoft.com)"
The word 'cryptographic' can be left out if the rouines from the library being used are not cryptographic related :-).
4. If you include any Windows specific code (or a derivative thereof) from the apps directory (application code) you must include an acknowledgement:
"This product includes software written by Tim Hudson (tjh@cryptsoft.com)"

THIS SOFTWARE IS PROVIDED BY ERIC YOUNG "AS IS" AND ANY EXPRESS OR IMPLIED WARRANTIES, INCLUDING, BUT NOT LIMITED TO, THE IMPLIED WARRANTIES OF MERCHANTABILITY AND FITNESS FOR A PARTICULAR PURPOSE ARE DISCLAIMED. IN NO EVENT SHALL THE AUTHOR OR CONTRIBUTORS BE LIABLE FOR ANY DIRECT, INDIRECT, INCIDENTAL, SPECIAL, EXEMPLARY, OR CONSEQUENTIAL DAMAGES (INCLUDING, BUT NOT LIMITED TO, PROCUREMENT OF SUBSTITUTE GOODS OR SERVICES; LOSS OF USE, DATA, OR PROFITS; OR BUSINESS INTERRUPTION) HOWEVER CAUSED AND ON ANY THEORY OF LIABILITY, WHETHER IN CONTRACT, STRICT LIABILITY, OR TORT (INCLUDING NEGLIGENCE OR OTHERWISE) ARISING IN ANY WAY OUT OF THE USE OF THIS SOFTWARE, EVEN IF ADVISED OF THE POSSIBILITY OF SUCH DAMAGE.

The licence and distribution terms for any publically available version or derivative of this code cannot be changed. i.e. this code cannot simply be copied and put under another distribution licence [including the GNU Public Licence.]

[Net-SNMP License]

Various copyrights apply to this package, listed in 4 separate parts below. Please make sure that you read all the parts. Up until 2001, the project was based at UC Davis, and the first part covers all code written during this time. From 2001 onwards, the project has been based at SourceForge, and Networks Associates Technology, Inc hold the copyright on behalf of the wider Net-SNMP community, covering all derivative work done since then. An additional copyright section has been added as Part 3 below also under a BSD license for the work contributed by Cambridge Broadband Ltd. to the project since 2001.

An additional copyright section has been added as Part 4 below also under a BSD license for the work contributed by Sun Microsystems, Inc. to the project since 2003.

Code has been contributed to this project by many people over the years it has been in development, and a full list of contributors can be found in the README file under the

THANKS section.

--- Part 1: CMU/UCD copyright notice: (BSD like) ----

Copyright 1989, 1991, 1992 by Carnegie Mellon University
Derivative Work - 1996, 1998-2000
Copyright 1996, 1998-2000 The Regents of the University of California
All Rights Reserved

Permission to use, copy, modify and distribute this software and its documentation for any purpose and without fee is hereby granted, provided that the above copyright notice appears in all copies and that both that copyright notice and this permission notice appear in supporting documentation, and that the name of CMU and The Regents of the University of California not be used in advertising or publicity pertaining to distribution of the software without specific written permission.

CMU AND THE REGENTS OF THE UNIVERSITY OF CALIFORNIA DISCLAIM ALL WARRANTIES WITH REGARD TO THIS SOFTWARE, INCLUDING ALL IMPLIED WARRANTIES OF MERCHANTABILITY AND FITNESS. IN NO EVENT SHALL CMU OR THE REGENTS OF THE UNIVERSITY OF CALIFORNIA BE LIABLE FOR ANY SPECIAL, INDIRECT OR CONSEQUENTIAL DAMAGES OR ANY DAMAGES WHATSOEVER RESULTING FROM THE LOSS OF USE, DATA OR PROFITS, WHETHER IN AN ACTION OF CONTRACT, NEGLIGENCE OR OTHER TORTIOUS ACTION, ARISING OUT OF OR IN CONNECTION WITH THE USE OR PERFORMANCE OF THIS SOFTWARE.

---- Part 2: Networks Associates Technology, Inc copyright notice (BSD) ----

Copyright (c) 2001-2003, Networks Associates Technology, Inc
All rights reserved.

- * Redistributions of source code must retain the above copyright notice, this list of conditions and the following disclaimer.
- * Redistributions in binary form must reproduce the above copyright notice, this list of conditions and the following disclaimer in the documentation and/or other materials provided with the distribution.
- * Neither the name of the Networks Associates Technology, Inc nor the names of its contributors may be used to endorse or promote products derived from this software without specific prior written permission.

THIS SOFTWARE IS PROVIDED BY THE COPYRIGHT HOLDERS AND CONTRIBUTORS "AS IS" AND ANY EXPRESS OR IMPLIED WARRANTIES, INCLUDING, BUT NOT LIMITED TO, THE IMPLIED WARRANTIES OF MERCHANTABILITY AND FITNESS FOR A PARTICULAR PURPOSE ARE DISCLAIMED. IN NO EVENT SHALL THE COPYRIGHT HOLDERS OR CONTRIBUTORS BE LIABLE FOR ANY DIRECT, INDIRECT, INCIDENTAL, SPECIAL, EXEMPLARY, OR CONSEQUENTIAL DAMAGES (INCLUDING, BUT NOT LIMITED TO, PROCUREMENT OF SUBSTITUTE GOODS OR SERVICES; LOSS OF USE, DATA, OR PROFITS; OR BUSINESS INTERRUPTION) HOWEVER CAUSED AND ON ANY THEORY OF LIABILITY, WHETHER IN CONTRACT, STRICT LIABILITY, OR TORT (INCLUDING NEGLIGENCE OR OTHERWISE) ARISING IN ANY WAY OUT OF THE USE OF THIS SOFTWARE, EVEN IF ADVISED OF THE POSSIBILITY OF SUCH DAMAGE.

--- Part 3: Cambridge Broadband Ltd. copyright notice (BSD) ----
Portions of this code are copyright (c) 2001-2003, Cambridge Broadband Ltd.
All rights reserved.

Redistribution and use in source and binary forms, with or without modification, are permitted provided that the following conditions are met:

- * Redistributions of source code must retain the above copyright notice, this list of conditions and the following disclaimer.
- * Redistributions in binary form must reproduce the above copyright notice, this list of conditions and the following disclaimer in the documentation and/or other materials provided with the distribution.
- * The name of Cambridge Broadband Ltd. may not be used to endorse or promote products derived from this software without specific prior written permission.

THIS SOFTWARE IS PROVIDED BY THE COPYRIGHT HOLDER "AS IS" AND ANY EXPRESS OR IMPLIED WARRANTIES, INCLUDING, BUT NOT LIMITED TO, THE IMPLIED WARRANTIES OF MERCHANTABILITY AND FITNESS FOR A PARTICULAR PURPOSE

ARE DISCLAIMED. IN NO EVENT SHALL THE COPYRIGHT HOLDER BE LIABLE FOR ANY DIRECT, INDIRECT, INCIDENTAL, SPECIAL, EXEMPLARY, OR CONSEQUENTIAL DAMAGES (INCLUDING, BUT NOT LIMITED TO, PROCUREMENT OF SUBSTITUTE GOODS OR SERVICES; LOSS OF USE, DATA, OR PROFITS; OR BUSINESS INTERRUPTION) HOWEVER CAUSED AND ON ANY THEORY OF LIABILITY, WHETHER IN CONTRACT, STRICT LIABILITY, OR TORT (INCLUDING NEGLIGENCE OR OTHERWISE) ARISING IN ANY WAY OUT OF THE USE OF THIS SOFTWARE, EVEN IF ADVISED OF THE POSSIBILITY OF SUCH DAMAGE.

---- Part 4: Sun Microsystems, Inc. copyright notice (BSD) ----
Copyright 2003 Sun Microsystems, Inc., 4150 Network Circle, Santa Clara, California 95054, U.S.A.
All rights reserved.

Use is subject to license terms below.

This distribution may include materials developed by third parties.

Sun, Sun Microsystems, the Sun logo and Solaris are trademarks or registered trademarks of Sun Microsystems, Inc. in the U.S. and other countries.

Redistribution and use in source and binary forms, with or without modification, are permitted provided that the following conditions are met:

- * Redistributions of source code must retain the above copyright notice, this list of conditions and the following disclaimer.
- * Redistributions in binary form must reproduce the above copyright notice, this list of conditions and the following disclaimer in the documentation and/or other materials provided with the distribution.
- * Neither the name of the Sun Microsystems, Inc. nor the names of its contributors may be used to endorse or promote products derived from this software without specific prior written permission.

THIS SOFTWARE IS PROVIDED BY THE COPYRIGHT HOLDERS AND CONTRIBUTORS "AS IS" AND ANY EXPRESS OR IMPLIED WARRANTIES, INCLUDING, BUT NOT LIMITED TO, THE IMPLIED WARRANTIES OF MERCHANTABILITY AND FITNESS FOR A PARTICULAR PURPOSE ARE DISCLAIMED. IN NO EVENT SHALL THE COPYRIGHT HOLDERS OR CONTRIBUTORS BE LIABLE FOR ANY DIRECT, INDIRECT, INCIDENTAL, SPECIAL, EXEMPLARY, OR CONSEQUENTIAL DAMAGES (INCLUDING, BUT NOT LIMITED TO, PROCUREMENT OF SUBSTITUTE GOODS OR SERVICES; LOSS OF USE, DATA, OR PROFITS; OR BUSINESS INTERRUPTION) HOWEVER CAUSED AND ON ANY THEORY OF LIABILITY, WHETHER IN CONTRACT, STRICT LIABILITY, OR TORT (INCLUDING NEGLIGENCE OR OTHERWISE) ARISING IN ANY WAY OUT OF THE USE OF THIS SOFTWARE, EVEN IF ADVISED OF THE POSSIBILITY OF SUCH DAMAGE.

[dhcpcv6]

Copyright (C) International Business Machines Corp., 2003
All rights reserved.

Redistribution and use in source and binary forms, with or without * modification, are permitted provided that the following conditions are met:

- 1.Redistributions of source code must retain the above copyright notice, this list of conditions and the following disclaimer.
- 2.Redistributions in binary form must reproduce the above copyright notice, this list of conditions and the following disclaimer in the documentation and/or other materials provided with the distribution.
- 3.Neither the name of the project nor the names of its contributors may be used to endorse or promote products derived from this software without specific prior written permission.

THIS SOFTWARE IS PROVIDED BY THE PROJECT AND CONTRIBUTORS "AS IS" AND ANY EXPRESS OR IMPLIED WARRANTIES, INCLUDING, BUT NOT LIMITED TO, THE IMPLIED WARRANTIES OF MERCHANTABILITY AND FITNESS FOR A PARTICULAR PURPOSE ARE DISCLAIMED. IN NO EVENT SHALL THE PROJECT OR CONTRIBUTORS BE LIABLE FOR ANY DIRECT, INDIRECT, INCIDENTAL, SPECIAL, EXEMPLARY, OR CONSEQUENTIAL DAMAGES (INCLUDING, BUT NOT LIMITED TO, PROCUREMENT OF SUBSTITUTE GOODS OR SERVICES; LOSS OF USE, DATA, OR PROFITS; OR BUSINESS INTERRUPTION) HOWEVER CAUSED AND ON ANY THEORY OF LIABILITY, WHETHER IN CONTRACT, STRICT LIABILITY, OR TORT (INCLUDING NEGLIGENCE OR OTHERWISE) ARISING IN ANY WAY OUT OF THE

USE OF THIS SOFTWARE, EVEN IF ADVISED OF THE POSSIBILITY OF SUCH DAMAGE.

[libtar]

Copyright (c) 1998-2003 University of Illinois Board of Trustees

Copyright (c) 1998-2003 Mark D. Roth

All rights reserved.

Developed by: Campus Information Technologies and Educational Services, University of Illinois at Urbana-Champaign

Permission is hereby granted, free of charge, to any person obtaining a copy of this software and associated documentation files (the "Software"), to deal with the Software without restriction, including without limitation the rights to use, copy, modify, merge, publish, distribute, sublicense, and/or sell copies of the Software, and to permit persons to whom the Software is furnished to do so, subject to the following conditions:

- * Redistributions of source code must retain the above copyright notice, this list of conditions and the following disclaimers.
- * Redistributions in binary form must reproduce the above copyright notice, this list of conditions and the following disclaimers in the documentation and/or other materials provided with the distribution.
- * Neither the names of Campus Information Technologies and Educational Services, University of Illinois at Urbana-Champaign, nor the names of its contributors may be used to endorse or promote products derived from this Software without specific prior written permission.

THE SOFTWARE IS PROVIDED "AS IS", WITHOUT WARRANTY OF ANY KIND, EXPRESS OR IMPLIED, INCLUDING BUT NOT LIMITED TO THE WARRANTIES OF MERCHANTABILITY, FITNESS FOR A PARTICULAR PURPOSE AND NONINFRINGEMENT. IN NO EVENT SHALL THE CONTRIBUTORS OR COPYRIGHT HOLDERS BE LIABLE FOR ANY CLAIM, DAMAGES OR OTHER LIABILITY, WHETHER IN AN ACTION OF CONTRACT, TORT OR OTHERWISE, ARISING FROM, OUT OF OR IN CONNECTION WITH THE SOFTWARE OR THE USE OR OTHER DEALINGS WITH THE SOFTWARE.

[eCos]

This is the full text of the license as found on files within eCos covered by the eCos license. It should be read in conjunction with the GNU General Public License (GPL) on which it depends.

Copyright (C) 1998, 1999, 2000, 2001, 2002, 2003 Red Hat, Inc.

Copyright (C) 2002, 2003 John Dallaway

Copyright (C) 2002, 2003 Nick Garnett

Copyright (C) 2002, 2003 Jonathan Larmour

Copyright (C) 2002, 2003 Andrew Lunn

Copyright (C) 2002, 2003 Gary Thomas

Copyright (C) 2002, 2003 Bart Veer

eCos is free software; you can redistribute it and/or modify it under the terms of the GNU General Public License as published by the Free Software Foundation; either version 2 or (at your option) any later version.

eCos is distributed in the hope that it will be useful, but WITHOUT ANY WARRANTY; without even the implied warranty of MERCHANTABILITY or FITNESS FOR A PARTICULAR PURPOSE. See the GNU General Public License for more details.

You should have received a copy of the GNU General Public License along with eCos; if not, write to the Free Software Foundation, Inc., 59 Temple Place, Suite 330, Boston, MA 02111-1307 USA.

As a special exception, if other files instantiate templates or use macros or inline functions from this file, or you compile this file and link it with other works to produce a work based on this file, this file does not by itself cause the resulting work to be covered by the GNU General Public License. However the source code for this file must still be made available in accordance with section (3) of the GNU General Public License.

This exception does not invalidate any other reasons why a work based on this file might be covered by the GNU General Public License.

[Kerberos]

Copyright 1994 by the Massachusetts Institute of Technology.
All Rights Reserved.

Export of this software from the United States of America may

require a specific license from the United States Government. It is the responsibility of any person or organization contemplating export to obtain such a license before exporting. WITHIN THAT CONSTRAINT, permission to use, copy, modify, and distribute this software and its documentation for any purpose and without fee is hereby granted, provided that the above copyright notice appear in all copies and that both that copyright notice and this permission notice appear in supporting documentation, and that the name of M.I.T. not be used in advertising or publicity pertaining to distribution of the software without specific, written prior permission. Furthermore if you modify this software you must label your software as modified software and not distribute it in such a fashion that it might be confused with the original M.I.T. software. M.I.T. makes no representations about the suitability of this software for any purpose. It is provided "as is" without express or implied warranty.

[Kame IPv6 stack]

Copyright (C) 1995, 1996, 1997, and 1998 WIDE Project. All rights reserved.

Redistribution and use in source and binary forms, with or without modification, are permitted provided that the following conditions are met:

1. Redistributions of source code must retain the above copyright notice, this list of conditions and the following disclaimer.
2. Redistributions in binary form must reproduce the above copyright notice, this list of conditions and the following disclaimer in the documentation and/or other materials provided with the distribution.
3. Neither the name of the project nor the names of its contributors may be used to endorse or promote products derived from this software without specific prior written permission.

THIS SOFTWARE IS PROVIDED BY THE PROJECT AND CONTRIBUTORS "AS IS" AND ANY EXPRESS OR IMPLIED WARRANTIES, INCLUDING, BUT NOT LIMITED TO, THE IMPLIED WARRANTIES OF MERCHANTABILITY AND FITNESS FOR A PARTICULAR PURPOSE ARE DISCLAIMED. IN NO EVENT SHALL THE PROJECT OR CONTRIBUTORS BE LIABLE FOR ANY DIRECT, INDIRECT, INCIDENTAL, SPECIAL, EXEMPLARY, OR CONSEQUENTIAL DAMAGES (INCLUDING, BUT NOT LIMITED TO, PROCUREMENT OF SUBSTITUTE GOODS OR SERVICES; LOSS OF USE, DATA, OR PROFITS; OR BUSINESS INTERRUPTION) HOWEVER CAUSED AND ON ANY THEORY OF LIABILITY, WHETHER IN CONTRACT, STRICT LIABILITY, OR TORT (INCLUDING NEGLIGENCE OR OTHERWISE) ARISING IN ANY WAY OUT OF THE USE OF THIS SOFTWARE, EVEN IF ADVISED OF THE POSSIBILITY OF SUCH DAMAGE.

[MD5 Message-Digest Algorithm]

Copyright (C) 1991-2, RSA Data Security, Inc. Created 1991. All rights reserved.

[The Standard Function Library]

This product uses parts of the iMatix SFL, Copyright (c) 1991-2000 iMatix Corporation <<http://www.imatix.com>>.

[expat]

Copyright (c) 1998, 1999, 2000 Thai Open Source Software Center Ltd and Clark Cooper
Copyright (c) 2001, 2002, 2003, 2004, 2005, 2006 Expat maintainers.

Permission is hereby granted, free of charge, to any person obtaining a copy of this software and associated documentation files (the "Software"), to deal in the Software without restriction, including without limitation the rights to use, copy, modify, merge, publish, distribute, sublicense, and/or sell copies of the Software, and to permit persons to whom the Software is furnished to do so, subject to the following conditions:

The above copyright notice and this permission notice shall be included in all copies or substantial portions of the Software.

THE SOFTWARE IS PROVIDED "AS IS", WITHOUT WARRANTY OF ANY KIND, EXPRESS OR IMPLIED, INCLUDING BUT NOT LIMITED TO THE WARRANTIES OF MERCHANTABILITY, FITNESS FOR A PARTICULAR PURPOSE AND NONINFRINGEMENT. IN NO EVENT SHALL THE AUTHORS OR COPYRIGHT HOLDERS BE LIABLE FOR ANY CLAIM, DAMAGES OR OTHER LIABILITY, WHETHER IN AN ACTION OF CONTRACT, TORT OR OTHERWISE, ARISING FROM, OUT OF OR IN CONNECTION WITH THE SOFTWARE OR THE USE OR OTHER DEALINGS IN THE SOFTWARE.

[curl]

Copyright (c) 1996 - 2011, Daniel Stenberg, <daniel@haxx.se>.

All rights reserved.

Permission to use, copy, modify, and distribute this software for any purpose with or without fee is hereby granted, provided that the above copyright notice and this permission notice appear in all copies.

THE SOFTWARE IS PROVIDED "AS IS", WITHOUT WARRANTY OF ANY KIND, EXPRESS OR IMPLIED, INCLUDING BUT NOT LIMITED TO THE WARRANTIES OF MERCHANTABILITY, FITNESS FOR A PARTICULAR PURPOSE AND NONINFRINGEMENT OF THIRD PARTY RIGHTS. IN NO EVENT SHALL THE AUTHORS OR COPYRIGHT HOLDERS BE LIABLE FOR ANY CLAIM, DAMAGES OR OTHER LIABILITY, WHETHER IN AN ACTION OF CONTRACT, TORT OR OTHERWISE, ARISING FROM, OUT OF OR IN CONNECTION WITH THE SOFTWARE OR THE USE OR OTHER DEALINGS IN THE SOFTWARE.

Except as contained in this notice, the name of a copyright holder shall not be used in advertising or otherwise to promote the sale, use or other dealings in this Software without prior written authorization of the copyright holder.

[camellia]

Copyright (C) 2006,2007 NTT (Nippon Telegraph and Telephone Corporation) . All rights reserved.

Redistribution and use in source and binary forms, with or without modification, are permitted provided that the following conditions are met:

1. Redistributions of source code must retain the above copyright notice, this list of conditions and the following disclaimer as the first lines of this file unmodified.
2. Redistributions in binary form must reproduce the above copyright notice, this list of conditions and the following disclaimer in the documentation and/or other materials provided with the distribution.

THIS SOFTWARE IS PROVIDED BY NTT "AS IS" AND ANY EXPRESS OR IMPLIED WARRANTIES, INCLUDING, BUT NOT LIMITED TO, THE IMPLIED WARRANTIES OF MERCHANTABILITY AND FITNESS FOR A PARTICULAR PURPOSE ARE DISCLAIMED. IN NO EVENT SHALL NTT BE LIABLE FOR ANY DIRECT, INDIRECT, INCIDENTAL, SPECIAL, EXEMPLARY, OR CONSEQUENTIAL DAMAGES (INCLUDING, BUT NOT LIMITED TO, PROCUREMENT OF SUBSTITUTE GOODS OR SERVICES; LOSS OF USE, DATA, OR PROFITS; OR BUSINESS INTERRUPTION) HOWEVER CAUSED AND ON ANY THEORY OF LIABILITY, WHETHER IN CONTRACT, STRICT LIABILITY, OR TORT (INCLUDING NEGLIGENCE OR OTHERWISE) ARISING IN ANY WAY OUT OF THE USE OF THIS SOFTWARE, EVEN IF ADVISED OF THE POSSIBILITY OF SUCH DAMAGE.

[libxml2]

Copyright (C) 1998-2003 Daniel Veillard. All Rights Reserved.

Permission is hereby granted, free of charge, to any person obtaining a copy of this software and associated documentation files (the "Software"), to deal in the Software without restriction, including without limitation the rights to use, copy, modify, merge, publish, distribute, sublicense, and/or sell copies of the Software, and to permit persons to whom the Software is furnished to do so, subject to the following conditions:

The above copyright notice and this permission notice shall be included in all copies or substantial portions of the Software.

THE SOFTWARE IS PROVIDED "AS IS", WITHOUT WARRANTY OF ANY KIND, EXPRESS OR IMPLIED, INCLUDING BUT NOT LIMITED TO THE WARRANTIES OF MERCHANTABILITY, FITNESS FOR A PARTICULAR PURPOSE AND NONINFRINGEMENT. IN NO EVENT SHALL THE DANIEL VEILLARD BE LIABLE FOR ANY CLAIM, DAMAGES OR OTHER LIABILITY, WHETHER IN AN ACTION OF CONTRACT, TORT OR OTHERWISE, ARISING FROM, OUT OF OR IN CONNECTION WITH THE SOFTWARE OR THE USE OR OTHER DEALINGS IN THE SOFTWARE.

Except as contained in this notice, the name of Daniel Veillard shall not be used in advertising or otherwise to promote the sale, use or other dealings in this Software without prior written authorization from him.

[jansson]

Copyright (c) 2009-2012 Petri Lehtinen <petri@digip.org>

Permission is hereby granted, free of charge, to any person obtaining a copy of this software and associated documentation files (the "Software"), to deal in the Software without restriction, including without limitation the rights to use, copy, modify, merge, publish, distribute, sublicense, and/or sell copies of the Software, and to permit persons to whom the Software is furnished to do so, subject to the following conditions:

The above copyright notice and this permission notice shall be included in all copies or substantial portions of the Software.

THE SOFTWARE IS PROVIDED "AS IS", WITHOUT WARRANTY OF ANY KIND, EXPRESS OR IMPLIED, INCLUDING BUT NOT LIMITED TO THE WARRANTIES OF MERCHANTABILITY, FITNESS FOR A PARTICULAR PURPOSE AND NONINFRINGEMENT. IN NO EVENT SHALL THE AUTHORS OR COPYRIGHT HOLDERS BE LIABLE FOR ANY CLAIM, DAMAGES OR OTHER LIABILITY, WHETHER IN AN ACTION OF CONTRACT, TORT OR OTHERWISE, ARISING FROM, OUT OF OR IN CONNECTION WITH THE SOFTWARE OR THE USE OR OTHER DEALINGS IN THE SOFTWARE.

[OpenSOAP]

Copyright (c) 2001-2004 The OpenSOAP Project. All rights reserved.

Redistribution and use in source and binary forms, with or without modification, are permitted provided that the following conditions are met:

1. Redistributions of source code must retain the above copyright notice, this list of conditions and the following disclaimer.
2. Redistributions in binary form must reproduce the above copyright notice, this list of conditions and the following disclaimer in the documentation and/or other materials provided with the distribution.

THIS SOFTWARE IS PROVIDED BY THE OPENSOURCE PROJECT "AS IS" AND ANY EXPRESS OR IMPLIED WARRANTIES, INCLUDING, BUT NOT LIMITED TO, THE IMPLIED WARRANTIES OF MERCHANTABILITY AND FITNESS FOR A PARTICULAR PURPOSE ARE DISCLAIMED. IN NO EVENT SHALL THE OPENSOURCE PROJECT OR CONTRIBUTORS BE LIABLE FOR ANY DIRECT, INDIRECT, INCIDENTAL, SPECIAL, EXEMPLARY, OR CONSEQUENTIAL DAMAGES (INCLUDING, BUT NOT LIMITED TO, PROCUREMENT OF SUBSTITUTE GOODS OR SERVICES; LOSS OF USE, DATA, OR PROFITS; OR BUSINESS INTERRUPTION) HOWEVER CAUSED AND ON ANY THEORY OF LIABILITY, WHETHER IN CONTRACT, STRICT LIABILITY, OR TORT (INCLUDING NEGLIGENCE OR OTHERWISE) ARISING IN ANY WAY OUT OF THE USE OF THIS SOFTWARE, EVEN IF ADVISED OF THE POSSIBILITY OF SUCH DAMAGE.

The views and conclusions contained in the software and documentation are those of the authors and should not be interpreted as representing official policies, either expressed or implied, of the OpenSOAP Project.

[CyberLink]

Copyright (C) 2002-2003 Satoshi Konno
All rights reserved.

Redistribution and use in source and binary forms, with or without modification, are permitted provided that the following conditions are met:

1. Redistributions of source code must retain the above copyright notice, this list of conditions and the following disclaimer.
2. Redistributions in binary form must reproduce the above copyright notice, this list of conditions and the following disclaimer in the documentation and/or other materials provided with the distribution.
3. The name of the author may not be used to endorse or promote products derived from this software without specific prior written permission.

THIS SOFTWARE IS PROVIDED BY THE AUTHOR "AS IS" AND ANY EXPRESS OR IMPLIED WARRANTIES, INCLUDING, BUT NOT LIMITED TO, THE IMPLIED WARRANTIES OF MERCHANTABILITY AND FITNESS FOR A PARTICULAR PURPOSE ARE DISCLAIMED. IN NO EVENT SHALL THE AUTHOR BE LIABLE FOR ANY DIRECT, INDIRECT, INCIDENTAL, SPECIAL, EXEMPLARY, OR CONSEQUENTIAL DAMAGES (INCLUDING, BUT NOT

LIMITED TO, PROCUREMENT OF SUBSTITUTE GOODS OR SERVICES; LOSS OF USE, DATA, OR PROFITS; OR BUSINESS INTERRUPTION) HOWEVER CAUSED AND ON ANY THEORY OF LIABILITY, WHETHER IN CONTRACT, STRICT LIABILITY, OR TORT (INCLUDING NEGLIGENCE OR OTHERWISE) ARISING IN ANY WAY OUT OF THE USE OF THIS SOFTWARE, EVEN IF ADVISED OF THE POSSIBILITY OF SUCH DAMAGE.

[PlayReady]

This product contains technology subject to certain intellectual property rights of Microsoft. Use or distribution of this technology outside of this product is prohibited without the appropriate license(s) from Microsoft.

Company shall place the following statement in its end-user license agreements or user documentation for PlayReady Final Products:

"Content owners use Microsoft PlayReady™ content access technology to protect their intellectual property, including copyrighted content. This device uses PlayReady technology to access PlayReady-protected content and/or WMDRM-protected content. If the device fails to properly enforce restrictions on content usage, content owners may require Microsoft to revoke the device's ability to consume PlayReady-protected content. Revocation should not affect unprotected content or content protected by other content access technologies.

Content owners may require you to upgrade PlayReady to access their content. If you decline an upgrade, you will not be able to access content that requires the upgrade.

[DIAL server]

Copyright (c) 2012 Netflix, Inc.
All rights reserved.

Redistribution and use in source and binary forms, with or without modification, are permitted provided that the following conditions are met:

- Redistributions of source code must retain the above copyright notice, this list of conditions and the following disclaimer.
- Redistributions in binary form must reproduce the above copyright notice, this list of conditions and the following disclaimer in the documentation and/or other materials provided with the distribution.

THIS SOFTWARE IS PROVIDED BY NETFLIX, INC. AND CONTRIBUTORS "AS IS" AND ANY EXPRESS OR IMPLIED WARRANTIES, INCLUDING, BUT NOT LIMITED TO, THE IMPLIED WARRANTIES OF MERCHANTABILITY AND FITNESS FOR A PARTICULAR PURPOSE ARE DISCLAIMED. IN NO EVENT SHALL NETFLIX OR CONTRIBUTORS BE LIABLE FOR ANY DIRECT, INDIRECT, INCIDENTAL, SPECIAL, EXEMPLARY, OR CONSEQUENTIAL DAMAGES (INCLUDING, BUT NOT LIMITED TO, PROCUREMENT OF SUBSTITUTE GOODS OR SERVICES; LOSS OF USE, DATA, OR PROFITS; OR BUSINESS INTERRUPTION) HOWEVER CAUSED AND ON ANY THEORY OF LIABILITY, WHETHER IN CONTRACT, STRICT LIABILITY, OR TORT (INCLUDING NEGLIGENCE OR OTHERWISE) ARISING IN ANY WAY OUT OF THE USE OF THIS SOFTWARE, EVEN IF ADVISED OF THE POSSIBILITY OF SUCH DAMAGE.

[libxst]

Copyright (C) 2001-2002 Daniel Veillard. All Rights Reserved.

Permission is hereby granted, free of charge, to any person obtaining a copy of this software and associated documentation files (the "Software"), to deal in the Software without restriction, including without limitation the rights to use, copy, modify, merge, publish, distribute, sublicense, and/or sell copies of the Software, and to permit persons to whom the Software is furnished to do so, subject to the following conditions:

The above copyright notice and this permission notice shall be included in all copies or substantial portions of the Software.

THE SOFTWARE IS PROVIDED "AS IS", WITHOUT WARRANTY OF ANY KIND, EXPRESS OR IMPLIED, INCLUDING BUT NOT LIMITED TO THE WARRANTIES OF MERCHANTABILITY, FITNESS FOR A PARTICULAR PURPOSE AND NONINFRINGEMENT. IN NO EVENT SHALL THE DANIEL VEILLARD BE LIABLE FOR ANY CLAIM, DAMAGES OR OTHER LIABILITY, WHETHER IN AN ACTION OF CONTRACT, TORT OR OTHERWISE, ARISING FROM, OUT OF OR IN CONNECTION WITH THE SOFTWARE OR THE USE OR OTHER DEALINGS IN THE SOFTWARE.

Except as contained in this notice, the name of Daniel Veillard

shall not be used in advertising or otherwise to promote the sale, use or other dealings in this Software without prior written authorization from him.

[International Components for Unicode]

ICU License - ICU 1.8.1 and later
Copyright (c) 1995-2011 International Business Machines Corporation and others
All rights reserved.

Permission is hereby granted, free of charge, to any person obtaining a copy of this software and associated documentation files (the "Software"), to deal in the Software without restriction, including without limitation the rights to use, copy, modify, merge, publish, distribute, and/or sell copies of the Software, and to permit persons to whom the Software is furnished to do so, provided that the above copyright notice(s) and this permission notice appear in all copies of the Software and that both the above copyright notice(s) and this permission notice appear in supporting documentation.

THE SOFTWARE IS PROVIDED "AS IS", WITHOUT WARRANTY OF ANY KIND, EXPRESS OR IMPLIED, INCLUDING BUT NOT LIMITED TO THE WARRANTIES OF MERCHANTABILITY, FITNESS FOR A PARTICULAR PURPOSE AND NONINFRINGEMENT OF THIRD PARTY RIGHTS. IN NO EVENT SHALL THE COPYRIGHT HOLDER OR HOLDERS INCLUDED IN THIS NOTICE BE LIABLE FOR ANY CLAIM, OR ANY SPECIAL INDIRECT OR CONSEQUENTIAL DAMAGES, OR ANY DAMAGES WHATSOEVER RESULTING FROM LOSS OF USE, DATA OR PROFITS, WHETHER IN AN ACTION OF CONTRACT, NEGLIGENCE OR OTHER TORTIOUS ACTION, ARISING OUT OF OR IN CONNECTION WITH THE USE OR PERFORMANCE OF THIS SOFTWARE.

Except as contained in this notice, the name of a copyright holder shall not be used in advertising or otherwise to promote the sale, use or other dealings in this Software without prior written authorization of the copyright holder.

UNICODE, INC. LICENSE AGREEMENT - DATA FILES AND SOFTWARE

Unicode Data Files include all data files under the directories <http://www.unicode.org/Public/>, <http://www.unicode.org/reports/>, and <http://www.unicode.org/cldr/data/>. Unicode Data Files do not include PDF online code charts under the directory <http://www.unicode.org/Public/>. Software includes any source code published in the Unicode Standard or under the directories <http://www.unicode.org/Public/>, <http://www.unicode.org/reports/>, and <http://www.unicode.org/cldr/data/>.

NOTICE TO USER: Carefully read the following legal agreement. BY DOWNLOADING, INSTALLING, COPYING OR OTHERWISE USING UNICODE INC.'S DATA FILES ("DATA FILES"), AND/OR SOFTWARE ("SOFTWARE"), YOU UNEQUIVOCALLY ACCEPT, AND AGREE TO BE BOUND BY, ALL OF THE TERMS AND CONDITIONS OF THIS AGREEMENT. IF YOU DO NOT AGREE, DO NOT DOWNLOAD, INSTALL, COPY, DISTRIBUTE OR USE THE DATA FILES OR SOFTWARE.

COPYRIGHT AND PERMISSION NOTICE

Copyright (c) 1991-2011 Unicode, Inc. All rights reserved. Distributed under the Terms of Use in <http://www.unicode.org/copyright.html>.

Permission is hereby granted, free of charge, to any person obtaining a copy of the Unicode data files and any associated documentation (the "Data Files") or Unicode software and any associated documentation (the "Software") to deal in the Data Files or Software without restriction, including without limitation the rights to use, copy, modify, merge, publish, distribute, and/or sell copies of the Data Files or Software, and to permit persons to whom the Data Files or Software are furnished to do so, provided that (a) the above copyright notice(s) and this permission notice appear with all copies of the Data Files or Software, (b) both the above copyright notice(s) and this permission notice appear in associated documentation, and (c) there is clear notice in each modified Data File or in the Software as well as in the documentation associated with the Data File(s) or Software that the data or software has been modified.

THE DATA FILES AND SOFTWARE ARE PROVIDED "AS IS", WITHOUT WARRANTY OF ANY KIND, EXPRESS OR IMPLIED, INCLUDING BUT NOT LIMITED TO THE WARRANTIES OF MERCHANTABILITY, FITNESS FOR

A PARTICULAR PURPOSE AND NONINFRINGEMENT OF THIRD PARTY RIGHTS. IN NO EVENT SHALL THE COPYRIGHT HOLDER OR HOLDERS INCLUDED IN THIS NOTICE BE LIABLE FOR ANY CLAIM, OR ANY SPECIAL INDIRECT OR CONSEQUENTIAL DAMAGES, OR ANY DAMAGES WHATSOEVER RESULTING FROM LOSS OF USE, DATA OR PROFITS, WHETHER IN AN ACTION OF CONTRACT, NEGLIGENCE OR OTHER TORTIOUS ACTION, ARISING OUT OF OR IN CONNECTION WITH THE USE OR PERFORMANCE OF THE DATA FILES OR SOFTWARE.

Except as contained in this notice, the name of a copyright holder shall not be used in advertising or otherwise to promote the sale, use or other dealings in these Data Files or Software without prior written authorization of the copyright holder.

[c-ares]

Copyright 1998 by the Massachusetts Institute of Technology.

Permission to use, copy, modify, and distribute this software and its documentation for any purpose and without fee is hereby granted, provided that the above copyright notice appear in all copies and that both that copyright notice and this permission notice appear in supporting documentation, and that the name of M.I.T. not be used in advertising or publicity pertaining to distribution of the software without specific, written prior permission.

M.I.T. makes no representations about the suitability of this software for any purpose. It is provided "as is" without express or implied warranty.

[Backbone.js]

Copyright (c) 2010-2013 Jeremy Ashkenas, DocumentCloud

Permission is hereby granted, free of charge, to any person obtaining a copy of this software and associated documentation files (the "Software"), to deal in the Software without restriction, including without limitation the rights to use, copy, modify, merge, publish, distribute, sublicense, and/or sell copies of the Software, and to permit persons to whom the Software is furnished to do so, subject to the following conditions:

The above copyright notice and this permission notice shall be included in all copies or substantial portions of the Software.

THE SOFTWARE IS PROVIDED "AS IS", WITHOUT WARRANTY OF ANY KIND, EXPRESS OR IMPLIED, INCLUDING BUT NOT LIMITED TO THE WARRANTIES OF MERCHANTABILITY, FITNESS FOR A PARTICULAR PURPOSE AND NONINFRINGEMENT. IN NO EVENT SHALL THE AUTHORS OR COPYRIGHT HOLDERS BE LIABLE FOR ANY CLAIM, DAMAGES OR OTHER LIABILITY, WHETHER IN AN ACTION OF CONTRACT, TORT OR OTHERWISE, ARISING FROM, OUT OF OR IN CONNECTION WITH THE SOFTWARE OR THE USE OR OTHER DEALINGS IN THE SOFTWARE.

[Bootstrap]

Copyright 2012 Twitter, Inc.

Licensed under the Apache License, Version 2.0 (the "License"); you may not use this file except in compliance with the License.

You may obtain a copy of the License at

<http://www.apache.org/licenses/LICENSE-2.0>

Unless required by applicable law or agreed to in writing, software distributed under the License is distributed on an "AS IS" BASIS, WITHOUT WARRANTIES OR CONDITIONS OF ANY KIND, either express or implied.

See the License for the specific language governing permissions and limitations under the License.

[jQuery]

Copyright 2012 jQuery Foundation and other contributors
<http://jquery.com/>

Permission is hereby granted, free of charge, to any person obtaining a copy of this software and associated documentation files (the "Software"), to deal in the Software without restriction, including without limitation the rights to use, copy, modify, merge, publish, distribute, sublicense, and/or sell copies of the Software, and to permit persons to whom the Software is furnished to do so, subject to the following conditions:

The above copyright notice and this permission notice shall be included in all copies or substantial portions of the Software.

THE SOFTWARE IS PROVIDED "AS IS", WITHOUT WARRANTY OF ANY KIND, EXPRESS OR IMPLIED, INCLUDING BUT NOT LIMITED TO THE WARRANTIES OF MERCHANTABILITY, FITNESS FOR A PARTICULAR PURPOSE AND NONINFRINGEMENT. IN NO EVENT SHALL THE AUTHORS OR COPYRIGHT HOLDERS BE LIABLE FOR ANY CLAIM, DAMAGES OR OTHER LIABILITY, WHETHER IN AN ACTION OF CONTRACT, TORT OR OTHERWISE, ARISING FROM, OUT OF OR IN CONNECTION WITH THE SOFTWARE OR THE USE OR OTHER DEALINGS IN THE SOFTWARE.

[RequireJS]

Copyright (c) 2010-2011, The Dojo Foundation

Permission is hereby granted, free of charge, to any person obtaining a copy of this software and associated documentation files (the "Software"), to deal in the Software without restriction, including without limitation the rights to use, copy, modify, merge, publish, distribute, sublicense, and/or sell copies of the Software, and to permit persons to whom the Software is furnished to do so, subject to the following conditions:

The above copyright notice and this permission notice shall be included in all copies or substantial portions of the Software.

THE SOFTWARE IS PROVIDED "AS IS", WITHOUT WARRANTY OF ANY KIND, EXPRESS OR IMPLIED, INCLUDING BUT NOT LIMITED TO THE WARRANTIES OF MERCHANTABILITY, FITNESS FOR A PARTICULAR PURPOSE AND NONINFRINGEMENT. IN NO EVENT SHALL THE AUTHORS OR COPYRIGHT HOLDERS BE LIABLE FOR ANY CLAIM, DAMAGES OR OTHER LIABILITY, WHETHER IN AN ACTION OF CONTRACT, TORT OR OTHERWISE, ARISING FROM, OUT OF OR IN CONNECTION WITH THE SOFTWARE OR THE USE OR OTHER DEALINGS IN THE SOFTWARE.

[Underscore.js]

Copyright (c) 2009-2012 Jeremy Ashkenas, DocumentCloud

Permission is hereby granted, free of charge, to any person obtaining a copy of this software and associated documentation files (the "Software"), to deal in the Software without restriction, including without limitation the rights to use, copy, modify, merge, publish, distribute, sublicense, and/or sell copies of the Software, and to permit persons to whom the Software is furnished to do so, subject to the following conditions:

The above copyright notice and this permission notice shall be included in all copies or substantial portions of the Software.

THE SOFTWARE IS PROVIDED "AS IS", WITHOUT WARRANTY OF ANY KIND, EXPRESS OR IMPLIED, INCLUDING BUT NOT LIMITED TO THE WARRANTIES OF MERCHANTABILITY, FITNESS FOR A PARTICULAR PURPOSE AND NONINFRINGEMENT. IN NO EVENT SHALL THE AUTHORS OR COPYRIGHT HOLDERS BE LIABLE FOR ANY CLAIM, DAMAGES OR OTHER LIABILITY, WHETHER IN AN ACTION OF CONTRACT, TORT OR OTHERWISE, ARISING FROM, OUT OF OR IN CONNECTION WITH THE SOFTWARE OR THE USE OR OTHER DEALINGS IN THE SOFTWARE.

[jQuery]

Copyright (c) 2011 Stan Lemon

Permission is hereby granted, free of charge, to any person obtaining a copy of this software and associated documentation files (the "Software"), to deal in the Software without restriction, including without limitation the rights to use, copy, modify, merge, publish, distribute, sublicense, and/or sell copies of the Software, and to permit persons to whom the Software is furnished to do so, subject to the following conditions:

The above copyright notice and this permission notice shall be included in all copies or substantial portions of the Software.

THE SOFTWARE IS PROVIDED "AS IS", WITHOUT WARRANTY OF ANY KIND, EXPRESS OR IMPLIED, INCLUDING BUT NOT LIMITED TO THE WARRANTIES OF MERCHANTABILITY, FITNESS FOR A PARTICULAR PURPOSE AND NONINFRINGEMENT. IN NO EVENT SHALL THE AUTHORS OR COPYRIGHT HOLDERS BE LIABLE FOR ANY CLAIM, DAMAGES OR OTHER LIABILITY, WHETHER IN AN ACTION OF CONTRACT, TORT OR OTHERWISE, ARISING FROM, OUT OF OR IN CONNECTION WITH THE

SOFTWARE OR THE USE OR OTHER DEALINGS IN THE SOFTWARE.

[pixman]

Copyright 1987, 1988, 1989, 1998 The Open Group
Copyright 1987, 1988, 1989 Digital Equipment Corporation
Copyright 1999, 2004, 2008 Keith Packard
Copyright 2000 SuSE, Inc.
Copyright 2000 Keith Packard, member of The XFree86 Project, Inc.
Copyright 2004, 2005, 2007, 2008, 2009, 2010 Red Hat, Inc.
Copyright 2004 Nicholas Miell
Copyright 2005 Lars Knoll & Zack Rusin, Trolltech
Copyright 2005 Trolltech AS
Copyright 2007 Luca Barbato
Copyright 2008 Aaron Plattner, NVIDIA Corporation
Copyright 2008 Rodrigo Kumpera
Copyright 2008 André Tupinambá
Copyright 2008 Mozilla Corporation
Copyright 2008 Frederic Plourde
Copyright 2009, Oracle and/or its affiliates. All rights reserved.
Copyright 2009, 2010 Nokia Corporation

Permission is hereby granted, free of charge, to any person obtaining a copy of this software and associated documentation files (the "Software"), to deal in the Software without restriction, including without limitation the rights to use, copy, modify, merge, publish, distribute, sublicense, and/or sell copies of the Software, and to permit persons to whom the Software is furnished to do so, subject to the following conditions:

The above copyright notice and this permission notice (including the next paragraph) shall be included in all copies or substantial portions of the Software.

THE SOFTWARE IS PROVIDED "AS IS", WITHOUT WARRANTY OF ANY KIND, EXPRESS OR IMPLIED, INCLUDING BUT NOT LIMITED TO THE WARRANTIES OF MERCHANTABILITY, FITNESS FOR A PARTICULAR PURPOSE AND NONINFRINGEMENT. IN NO EVENT SHALL THE AUTHORS OR COPYRIGHT HOLDERS BE LIABLE FOR ANY CLAIM, DAMAGES OR OTHER LIABILITY, WHETHER IN AN ACTION OF CONTRACT, TORT OR OTHERWISE, ARISING FROM, OUT OF OR IN CONNECTION WITH THE SOFTWARE OR THE USE OR OTHER DEALINGS IN THE SOFTWARE.

[Mozilla Public License]

This procut includes the following software licensed for use under the term of Mozilla Public License Version 2.0.

- PublicSuffixList
- CertList

Mozilla Public License Version 2.0

1. Definitions

- 1.1. "Contributor"
means each individual or legal entity that creates, contributes to the creation of, or owns Covered Software.
- 1.2. "Contributor Version"
means the combination of the Contributions of others (if any) used by a Contributor and that particular Contributor's Contribution.
- 1.3. "Contribution"
means Covered Software of a particular Contributor.
- 1.4. "Covered Software"
means Source Code Form to which the initial Contributor has attached the notice in Exhibit A, the Executable Form of such Source Code Form, and Modifications of such Source Code Form, in each case including portions thereof.
- 1.5. "Incompatible With Secondary Licenses"
means
(a) that the initial Contributor has attached the notice described in Exhibit B to the Covered Software; or
(b) that the Covered Software was made available under the terms of version 1.1 or earlier of the License, but not also under the terms of a Secondary License.
- 1.6. "Executable Form"
means any form of the work other than Source Code Form.
- 1.7. "Larger Work"
means a work that combines Covered Software with other material, in a separate file or files, that is not Covered Software.
- 1.8. "License"
means this document.

- 1.9. "Licensable"
means having the right to grant, to the maximum extent possible, whether at the time of the initial grant or subsequently, any and all of the rights conveyed by this License.
- 1.10. "Modifications"
means any of the following:
(a) any file in Source Code Form that results from an addition to, deletion from, or modification of the contents of Covered Software; or
(b) any new file in Source Code Form that contains any Covered Software.
- 1.11. "Patent Claims" of a Contributor
means any patent claim(s), including without limitation, method, process, and apparatus claims, in any patent Licensable by such Contributor that would be infringed, but for the grant of the License, by the making, using, selling, offering for sale, having made, import, or transfer of either its Contributions or its Contributor Version.
- 1.12. "Secondary License"
means either the GNU General Public License, Version 2.0, the GNU Lesser General Public License, Version 2.1, the GNU Affero General Public License, Version 3.0, or any later versions of those licenses.
- 1.13. "Source Code Form"
means the form of the work preferred for making modifications.
- 1.14. "You" (or "Your")
means an individual or a legal entity exercising rights under this License. For legal entities, "You" includes any entity that controls, is controlled by, or is under common control with You. For purposes of this definition, "control" means (a) the power, direct or indirect, to cause the direction or management of such entity, whether by contract or otherwise, or (b) ownership of more than fifty percent (50%) of the outstanding shares or beneficial ownership of such entity.

2. License Grants and Conditions

2.1. Grants

Each Contributor hereby grants You a world-wide, royalty-free, non-exclusive license:

- (a) under intellectual property rights (other than patent or trademark) Licensable by such Contributor to use, reproduce, make available, modify, display, perform, distribute, and otherwise exploit its Contributions, either on an unmodified basis, with Modifications, or as part of a Larger Work; and
(b) under Patent Claims of such Contributor to make, use, sell, offer for sale, have made, import, and otherwise transfer either its Contributions or its Contributor Version.

2.2. Effective Date

The licenses granted in Section 2.1 with respect to any Contribution become effective for each Contribution on the date the Contributor first distributes such Contribution.

2.3. Limitations on Grant Scope

The licenses granted in this Section 2 are the only rights granted under this License. No additional rights or licenses will be implied from the distribution or licensing of Covered Software under this License. Notwithstanding Section 2.1(b) above, no patent license is granted by a Contributor:

- (a) for any code that a Contributor has removed from Covered Software; or
(b) for infringements caused by: (i) Your and any other third party's modifications of Covered Software, or (ii) the combination of its Contributions with other software (except as part of its Contributor Version); or
(c) under Patent Claims infringed by Covered Software in the absence of its Contributions.

This License does not grant any rights in the trademarks, service marks, or logos of any Contributor (except as may be necessary to comply with the notice requirements in Section 3.4).

2.4. Subsequent Licenses

No Contributor makes additional grants as a result of Your choice to distribute the Covered Software under a subsequent version of this License (see Section 10.2) or under the terms of a Secondary License (if permitted under the terms of Section 3.3).

2.5. Representation

Each Contributor represents that the Contributor believes its Contributions are its original creation(s) or it has sufficient rights to grant the rights to its Contributions conveyed by this License.

2.6. Fair Use

This License is not intended to limit any rights You have

under applicable copyright doctrines of fair use, fair dealing, or other equivalents.

2.7. Conditions

Sections 3.1, 3.2, 3.3, and 3.4 are conditions of the licenses granted in Section 2.1.

3. Responsibilities

3.1. Distribution of Source Form

All distribution of Covered Software in Source Code Form, including any Modifications that You create or to which You contribute, must be under the terms of this License. You must inform recipients that the Source Code Form of the Covered Software is governed by the terms of this License, and how they can obtain a copy of this License. You may not attempt to alter or restrict the recipients' rights in the Source Code Form.

3.2. Distribution of Executable Form

If You distribute Covered Software in Executable Form then:

- (a) such Covered Software must also be made available in Source Code Form, as described in Section 3.1, and You must inform recipients of the Executable Form how they can obtain a copy of such Source Code Form by reasonable means in a timely manner, at a charge no more than the cost of distribution to the recipient; and
(b) You may distribute such Executable Form under the terms of this License, or sublicense it under different terms, provided that the license for the Executable Form does not attempt to limit or alter the recipients' rights in the Source Code Form under this License.

3.3. Distribution of a Larger Work

You may create and distribute a Larger Work under terms of Your choice, provided that You also comply with the requirements of this License for the Covered Software. If the Larger Work is a combination of Covered Software with a work governed by one or more Secondary Licenses, and the Covered Software is not Incompatible With Secondary Licenses, this License permits You to additionally distribute such Covered Software under the terms of such Secondary License(s), so that the recipient of the Larger Work may, at their option, further distribute the Covered Software under the terms of either this License or such Secondary License(s).

3.4. Notices

You may not remove or alter the substance of any license notices (including copyright notices, patent notices, disclaimers of warranty, or limitations of liability) contained within the Source Code Form of the Covered Software, except that You may alter any license notices to the extent required to remedy known factual inaccuracies.

3.5. Application of Additional Terms

You may choose to offer, and to charge a fee for, warranty, support, indemnity or liability obligations to one or more recipients of Covered Software. However, You may do so only on Your own behalf, and not on behalf of any Contributor. You must make it absolutely clear that any such warranty, support, indemnity, or liability obligation is offered by You alone, and You hereby agree to indemnify every Contributor for any liability incurred by such Contributor as a result of warranty, support, indemnity or liability terms You offer. You may include additional disclaimers of warranty and limitations of liability specific to any jurisdiction.

4. Inability to Comply Due to Statute or Regulation

If it is impossible for You to comply with any of the terms of this License with respect to some or all of the Covered Software due to statute, judicial order, or regulation then You must: (a) comply with the terms of this License to the maximum extent possible; and (b) describe the limitations and the code they affect. Such description must be placed in a text file included with all distributions of the Covered Software under this License. Except to the extent prohibited by statute or regulation, such description must be sufficiently detailed for a recipient of ordinary skill to be able to understand it.

5. Termination

5.1. The rights granted under this License will terminate automatically

if You fail to comply with any of its terms. However, if You become compliant, then the rights granted under this License from a particular Contributor are reinstated (a) provisionally, unless and until such Contributor explicitly and finally terminates Your grants, and (b) on an ongoing basis, if such Contributor fails to notify You of the non-compliance by some reasonable means prior to 60 days after You have come back into compliance. Moreover, Your grants from a particular Contributor are reinstated

on an ongoing basis if such Contributor notifies You of the non-compliance by some reasonable means, this is the first time You have received notice of non-compliance with this License from such Contributor, and You become compliant prior to 30 days after Your receipt of the notice.

- 5.2. If You initiate litigation against any entity by asserting a patent infringement claim (excluding declaratory judgment actions, counter-claims, and cross-claims) alleging that a Contributor Version directly or indirectly infringes any patent, then the rights granted to You by any and all Contributors for the Covered Software under Section 2.1 of this License shall terminate.
- 5.3. In the event of termination under Sections 5.1 or 5.2 above, all end user license agreements (excluding distributors and resellers) which have been validly granted by You or Your distributors under this License prior to termination shall survive termination.

6. Disclaimer of Warranty

Covered Software is provided under this License on an "as is" basis, without warranty of any kind, either expressed, implied, or statutory, including, without limitation, warranties that the Covered Software is free of defects, merchantable, fit for a particular purpose or non-infringing. The entire risk as to the quality and performance of the Covered Software is with You. Should any Covered Software prove defective in any respect, You (not any Contributor) assume the cost of any necessary servicing, repair, or correction. This disclaimer of warranty constitutes an essential part of this License. No use of any Covered Software is authorized under this License except under this disclaimer.

7. Limitation of Liability

Under no circumstances and under no legal theory, whether tort (including negligence), contract, or otherwise, shall any Contributor, or anyone who distributes Covered Software as permitted above, be liable to You for any direct, indirect, special, incidental, or consequential damages of any character including, without limitation, damages for lost profits, loss of goodwill, work stoppage, computer failure or malfunction, or any and all other commercial damages or losses, even if such party shall have been informed of the possibility of such damages. This limitation of liability shall not apply to liability for death or personal injury resulting from such party's negligence to the extent applicable law prohibits such limitation. Some jurisdictions do not allow the exclusion or limitation of incidental or consequential damages, so this exclusion and limitation may not apply to You.

8. Litigation

Any litigation relating to this License may be brought only in the courts of a jurisdiction where the defendant maintains its principal place of business and such litigation shall be governed by laws of that jurisdiction, without reference to its conflict-of-law provisions. Nothing in this Section shall prevent a party's ability to bring cross-claims or counter-claims.

9. Miscellaneous

This License represents the complete agreement concerning the subject matter hereof. If any provision of this License is held to be unenforceable, such provision shall be reformed only to the extent necessary to make it enforceable. Any law or regulation which provides that the language of a contract shall be construed against the drafter shall not be used to construe this License against a Contributor.

10. Versions of the License

- 10.1. New Versions
Mozilla Foundation is the license steward. Except as provided in Section 10.3, no one other than the license steward has the right to modify or publish new versions of this License. Each version will be given a distinguishing version number.
- 10.2. Effect of New Versions
You may distribute the Covered Software under the terms of the version of the License under which You originally received the Covered Software, or under the terms of any subsequent version published by the license steward.
- 10.3. Modified Versions
If you create software not governed by this License, and you want to create a new license for such software, you may create and use a modified version of this License if you rename the license and remove any references to the name of the license steward (except to note that such modified license differs from this License).
- 10.4. Distributing Source Code Form that is Incompatible With Secondary Licenses

If You choose to distribute Source Code Form that is Incompatible With Secondary Licenses under the terms of this version of the License, the notice described in Exhibit B of this License must be attached.

Exhibit A - Source Code Form License Notice

This Source Code Form is subject to the terms of the Mozilla Public License, v. 2.0. If a copy of the MPL was not distributed with this file, You can obtain one at <http://mozilla.org/MPL/2.0/>. If it is not possible or desirable to put the notice in a particular file, then You may include the notice in a location (such as a LICENSE file in a relevant directory) where a recipient would be likely to look for such a notice. You may add additional accurate notices of copyright ownership.

Exhibit B - "Incompatible With Secondary Licenses" Notice

This Source Code Form is "Incompatible With Secondary Licenses", as defined by the Mozilla Public License, v. 2.0.

[GNU GENERAL PUBLIC LICENSE and GNU LESSER GENERAL PUBLIC LICENSE]

本製品は、GNU General Public License (以下「GPL」とします) version 2 および GNU Lesser General Public License (以下「LGPL」とします) Version 2.0、Version 2.1 の条件にもとづいて利用が許諾された以下のソフトウェアを含んでいます。

- linux-3. Copyright (C) 1991 Linus Torvalds. Licensed under GPLv2.
 - avahi-0.6.21. Copyright 2004-2006 by the Avahi developers. Licensed under LGPLv2.1
 - BusyBox v1.19.4 multi-call binary.Copyright (C) 1998-2011 Erik Andersen, Rob Landley, Denys Vlasenko and others. Licensed under GPLv2.
 - dhcpcd-1.3.22-p14. Copyright (C) 1996 - 1997 Yoichi Hariguchi,January, 1998 Sergei Viznyuk. Licensed under GPLv2.
 - iptables-1.4.10. Copyright (C) 2000-2002 by the netfilter coreteam. Licensed under GPLv2.
 - mtd-utils-1.4.8. Copyright (C) 2d3d, Inc., 2007, 2008,2009 Nokia Corporation., International Business Machines Corp., 2006, 2008 Logitech., 2000 Arcom Control System Ltd, Artem Bitvutskiy, 2007, 2008., 2010 Mike Frysinger, 2010 Mike Frysinger, 2000 Steven J. Hill, 2003 Thomas Gleixner, 2000 David Woodhouse. Licensed under GPLv2.
 - uClibc-0.9.32. Copyright (C) 2000-2008 Erik Andersen. Licensed under LGPLv2.1
 - libiconv-1.11. Copyright (C) 2000-2006 Free Software Foundation, Inc. Licensed under LGPLv2.0.
 - xfsprogs-3.1.8. Copyright c 2000-2006 Silicon Graphics, Inc. Licensed under LGPLv2.1.
 - parted (GNU parted) 1.8.7. Copyright c 2007 Free Software Foundation, Inc. Licensed under LGPLv2.1.
 - dnsmasq version 1.8. Copyright c 2000 Simon Kelley.Licensed under GPLv2.
 - libconfig-1.4.8. Copyright (C) 2005-2010 Mark A Linder. Licensed under LGPLv2.1.
 - libsoap-1.1.0. Copyright (C) 2003-2004 Ferhat Ayaz. Licensed under LGPLv2.0.
 - smartmontools-6.1 Copyright (C) 2002-2013 BruceAllen,Christian Franke, www.smartmontools.org. Licensed under GPLv2.
 - gloox-1.0 Copyright (c) 2004-2009 by Jakob Schroeter. Licensed under GPLv2.
 - WebKit-137788 Licensed under LGPLv2.0.
 - Cairo-1.12.14 Licensed under LGPLv2.1.
 - FreeType-2.5.0. Copyright (C) 2006-2013 The FreeType Project. Licensed under GPLv2.
- 該当するソースコードの複製物は以下の URL からダウンロードできます。 <http://www.oss-pioneer.com/cablenetwork/stb> なお、ソースコードの内容についてのご質問にはお答えできませんので、あらかじめご了承ください。また、GNU GPL Version 2 および GNU LGPL Version 2.0、Version 2.1 の詳細については GNU のウェブサイトをご覧ください (<http://www.gnu.org/>)。

[GNU GENERAL PUBLIC LICENSE]

Version 2, June 1991
Copyright © 1989, 1991 Free Software Foundation, Inc., 51 Franklin Street, Fifth Floor, Boston, MA 02110-1301 USA
Everyone is permitted to copy and distribute verbatim copies of this license document, but changing it is not allowed.

Preamble

The licenses for most software are designed to take away your freedom to share and change it. By contrast, the GNU General Public License is intended to guarantee your freedom to share and change free software - to make sure the software is free for all its users. This General Public License applies to most of the Free Software Foundation's software and to any other program whose authors commit to using it. (Some other Free Software Foundation software is covered by the GNU Lesser General Public License instead.) You can apply it to your programs, too.

When we speak of free software, we are referring to freedom, not price. Our General Public Licenses are designed to make sure that you have the freedom to distribute copies of free software (and charge for this service if you wish), that you receive source code or can get it if you want it, that you can change the software or use pieces of it in new free programs; and that you know you can do these things.

To protect your rights, we need to make restrictions that forbid anyone to deny you these rights or to ask you to surrender the rights. These restrictions translate to certain responsibilities for you if you distribute copies of the software, or if you modify it. For example, if you distribute copies of such a program, whether gratis or for a fee, you must give the recipients all the rights that you have. You must make sure that they, too, receive or can get the source code. And you must show them these terms so they know their rights.

We protect your rights with two steps: (1) copyright the software, and (2) offer you this license which gives you legal permission to copy, distribute and/or modify the software.

Also, for each author's protection and ours, we want to make certain that everyone understands that there is no warranty for this free software. If the software is modified by someone else and passed on, we want its recipients to know that what they have is not the original, so that any problems introduced by others will not reflect on the original authors' reputations.

Finally, any free program is threatened constantly by software patents. We wish to avoid the danger that redistributors of a free program will individually obtain patent licenses, in effect making the program proprietary. To prevent this, we have made it clear that any patent must be licensed for everyone's free use or not licensed at all. The precise terms and conditions for copying, distribution and modification follow.

GNU GENERAL PUBLIC LICENSE

TERMS AND CONDITIONS FOR COPYING, DISTRIBUTION AND MODIFICATION

0. This License applies to any program or other work which contains a notice placed by the copyright holder saying it may be distributed under the terms of this General Public License. The "Program", below, refers to any such program or work, and a "work based on the Program" means either the Program or any derivative work under copyright law: that is to say, a work containing the Program or a portion of it, either verbatim or with modifications and/or translated into another language. (Hereinafter, translation is included without limitation in the term "modification".) Each licensee is addressed as "you". Activities other than copying, distribution and modification are not covered by this License; they are outside its scope. The act of running the Program is not restricted, and the output from the Program is covered only if its contents constitute a work based on the Program (independent of having been made by running the Program). Whether that is true depends on what the Program does.

1. You may copy and distribute verbatim copies of the Program's source code as you receive it, in any medium, provided that you conspicuously and appropriately publish on each copy an appropriate copyright notice and disclaimer of warranty; keep intact all the notices that refer to this License and to the absence of any warranty; and give any other recipients of the Program a copy of this License along with the Program. You may charge a fee for the physical act of transferring a copy, and you may at your option offer warranty protection in exchange for a fee.
2. You may modify your copy or copies of the Program or any portion of it, thus forming a work based on the Program, and copy and distribute such modifications or work under the terms of Section 1 above, provided that you also meet all of these conditions:
 - a) You must cause the modified files to carry prominent notices stating that you changed the files and the date of any change.
 - b) You must cause any work that you distribute or publish, that in whole or in part contains or is derived from the Program or any part thereof, to be licensed as a whole at no charge to all third parties under the terms of this License.
 - c) If the modified program normally reads commands interactively when run, you must cause it, when started running for such interactive use in the most ordinary way, to print or display an announcement including an appropriate copyright notice and a notice that there is no warranty (or else, saying that you provide a warranty) and that users may redistribute the program under these conditions, and telling the user how to view a copy of this License. (Exception: if the Program itself is interactive but does not normally print such an announcement, your work based on the Program is not required to print an announcement.) These requirements apply to the modified work as a whole. If identifiable sections of that work are not derived from the Program, and can be reasonably

considered independent and separate works in themselves, then this License, and its terms, do not apply to those sections when you distribute them as separate works. But when you distribute the same sections as part of a whole which is a work based on the Program, the distribution of the whole must be on the terms of this License, whose permissions for other licensees extend to the entire whole, and thus to each and every part regardless of who wrote it. Thus, it is not the intent of this section to claim rights or contest your rights to work written entirely by you; rather, the intent is to exercise the right to control the distribution of derivative or collective works based on the Program. In addition, mere aggregation of another work not based on the Program with the Program (or with a work based on the Program) on a volume of a storage or distribution medium does not bring the other work under the scope of this License.

3. You may copy and distribute the Program (or a work based on it, under Section 2) in object code or executable form under the terms of Sections 1 and 2 above provided that you also do one of the following:
 - a) Accompany it with the complete corresponding machine-readable source code, which must be distributed under the terms of Sections 1 and 2 above on a medium customarily used for software interchange; or,
 - b) Accompany it with a written offer, valid for at least three years, to give any third party, for a charge no more than your cost of physically performing source distribution, a complete machine-readable copy of the corresponding source code, to be distributed under the terms of Sections 1 and 2 above on a medium customarily used for software interchange; or, linking proprietary applications with the library. If this is what you want to do, use the GNU Lesser General Public License instead of this License.
 - c) Accompany it with the information you received as to the offer to distribute corresponding source code. (This alternative is allowed only for noncommercial distribution and only if you received the program in object code or executable form with such an offer, in accord with Subsection b above.) The source code for a work means the preferred form of the work for making modifications to it. For an executable work, complete source code means all the source code for all modules it contains, plus any associated interface definition files, plus the scripts used to control compilation and installation of the executable. However, as a special exception, the source code distributed need not include anything that is normally distributed (in either source or binary form) with the major components (compiler, kernel, and so on) of the operating system on which the executable runs, unless that component itself accompanies the executable. If distribution of executable or object code is made by offering access to copy from a designated place, then offering equivalent access to copy the source code from the same place counts as distribution of the source code, even though third parties are not compelled to copy the source along with the object code.
4. You may not copy, modify, sublicense, or distribute the Program except as expressly provided under this License. Any attempt otherwise to copy, modify, sublicense or distribute the Program is void, and will automatically terminate your rights under this License. However, parties who have received copies, or rights, from you under this License will not have their licenses terminated so long as such parties remain in full compliance.
5. You are not required to accept this License, since you have not signed it. However, nothing else grants you permission to modify or distribute the Program or its derivative works. These actions are prohibited by law if you do not accept this License. Therefore, by modifying or distributing the Program (or any work based on the Program), you indicate your acceptance of this License to do so, and all its terms and conditions for copying, distributing or modifying the Program or works based on it.
6. Each time you redistribute the Program (or any work based on the Program), the recipient automatically receives a license from the original licensor to copy, distribute or modify the Program subject to these terms and conditions. You may not impose any further restrictions on the recipients' exercise of the rights granted herein. You are not responsible for enforcing compliance by third parties with this License.
7. If, as a consequence of a court judgment or allegation of patent infringement or for any other reason (not limited to patent issues), conditions are imposed on you (whether by court order, agreement or otherwise) that contradict the conditions of this License, they do not excuse you from the conditions of this License. If you cannot distribute so as to satisfy simultaneously your obligations under this License and any other pertinent obligations, then as a consequence you may not distribute

the Program at all. For example, if a patent license would not permit royalty-free redistribution of the Program by all those who receive copies directly or indirectly through you, then the only way you could satisfy both it and this License would be to refrain entirely from distribution of the Program. If any portion of this section is held invalid or unenforceable under any particular circumstance, the balance of the section is intended to apply and the section as a whole is intended to apply in other circumstances. It is not the purpose of this section to induce you to infringe any patents or other property right claims or to contest validity of any such claims; this section has the sole purpose of protecting the integrity of the free software distribution system, which is implemented by public license practices. Many people have made generous contributions to the wide range of software distributed through that system in reliance on consistent application of that system; it is up to the author/donor to decide if he or she is willing to distribute software through any other system and a licensee cannot impose that choice. This section is intended to make thoroughly clear what is believed to be a consequence of the rest of this License.

8. If the distribution and/or use of the Program is restricted in certain countries either by patents or by copyrighted interfaces, the original copyright holder who places the Program under this License may add an explicit geographical distribution limitation excluding those countries, so that distribution is permitted only in or among countries not thus excluded. In such case, this License incorporates the limitation as if written in the body of this License.
9. The Free Software Foundation may publish revised and/or new versions of the General Public License from time to time. Such new versions will be similar in spirit to the present version, but may differ in detail to address new problems or concerns. Each version is given a distinguishing version number. If the Program specifies a version number of this License which applies to it and "any later version", you have the option of following the terms and conditions either of that version or of any later version published by the Free Software Foundation. If the Program does not specify a version number of this License, you may choose any version ever published by the Free Software Foundation.
10. If you wish to incorporate parts of the Program into other free programs whose distribution conditions are different, write to the author to ask for permission. For software which is copyrighted by the Free Software Foundation, write to the Free Software Foundation; we sometimes make exceptions for this. Our decision will be guided by the two goals of preserving the free status of all derivatives of our free software and of promoting the sharing and reuse of software generally.

NO WARRANTY

11. BECAUSE THE PROGRAM IS LICENSED FREE OF CHARGE, THERE IS NO WARRANTY FOR THE PROGRAM, TO THE EXTENT PERMITTED BY APPLICABLE LAW, EXCEPT WHEN OTHERWISE STATED IN WRITING THE COPYRIGHT HOLDERS AND/OR OTHER PARTIES PROVIDE THE PROGRAM "AS IS" WITHOUT WARRANTY OF ANY KIND, EITHER EXPRESSED OR IMPLIED, INCLUDING, BUT NOT LIMITED TO, THE IMPLIED WARRANTIES OF MERCHANTABILITY AND FITNESS FOR A PARTICULAR PURPOSE. THE ENTIRE RISK AS TO THE QUALITY AND PERFORMANCE OF THE PROGRAM IS WITH YOU. SHOULD THE PROGRAM PROVE DEFECTIVE, YOU ASSUME THE COST OF ALL NECESSARY SERVICING, REPAIR OR CORRECTION.
12. IN NO EVENT UNLESS REQUIRED BY APPLICABLE LAW OR AGREED TO IN WRITING WILL ANY COPYRIGHT HOLDER, OR ANY OTHER PARTY WHO MAY MODIFY AND/OR REDISTRIBUTE THE PROGRAM AS PERMITTED ABOVE, BE LIABLE TO YOU FOR DAMAGES, INCLUDING ANY GENERAL, SPECIAL, INCIDENTAL OR CONSEQUENTIAL DAMAGES ARISING OUT OF THE USE OR INABILITY TO USE THE PROGRAM (INCLUDING BUT NOT LIMITED TO LOSS OF DATA OR DATA BEING RENDERED INACCURATE OR LOSSES SUSTAINED BY YOU OR THIRD PARTIES OR A FAILURE OF THE PROGRAM TO OPERATE WITH ANY OTHER PROGRAMS), EVEN IF SUCH HOLDER OR OTHER PARTY HAS BEEN ADVISED OF THE POSSIBILITY OF SUCH DAMAGES.
END OF TERMS AND CONDITIONS

How to Apply These Terms to Your New Programs

If you develop a new program, and you want it to be of the greatest possible use to the public, the best way to achieve this is to make it free software which everyone can redistribute and change under these terms. To do so, attach the following notices to the program. It is safest to attach them to the start

of each source file to most effectively convey the exclusion of warranty; and each file should have at least the "copyright" line and a pointer to where the full notice is found.

<one line to give the program's name and a brief idea of what it does.>

Copyright © <year> <name of author>

This program is free software; you can redistribute it and/or modify it under the terms of the GNU General Public License as published by the Free Software Foundation; either version 2 of the License, or (at your option) any later version.

This program is distributed in the hope that it will be useful, but WITHOUT ANY WARRANTY; without even the implied warranty of MERCHANTABILITY or FITNESS FOR A PARTICULAR PURPOSE. See the GNU General Public License for more details.

You should have received a copy of the GNU General Public License along with this program; if not, write to the Free Software Foundation, Inc., 51 Franklin Street, Fifth Floor, Boston, MA 02110-1301 USA. Also add information on how to contact you by electronic and paper mail.

If the program is interactive, make it output a short notice like this when it starts in an interactive mode:

```
Gnomovision version 69, Copyright © year name of author
Gnomovision comes with ABSOLUTELY NO WARRANTY;
for details type 'show w'. This is free software, and
you are welcome to redistribute it under certain conditions;
type 'show c' for details.
```

The hypothetical commands 'show w' and 'show c' should show the appropriate parts of the General Public License. Of course, the commands you use may be called something other than 'show w' and 'show c'; they could even be mouse-clicks or menu items - whatever suits your program.

You should also get your employer (if you work as a programmer) or your school, if any, to sign a "copyright disclaimer" for the program, if necessary. Here is a sample; alter the names: Yoyodyne, Inc., hereby disclaims all copyright interest in the program 'Gnomovision' (which makes passes at compilers) written by James Hacker.

<signature of Ty Coon>, 1 April 1989

Ty Coon, President of Vice

This General Public License does not permit incorporating your program into proprietary programs. If your program is a subroutine library, you may consider it more useful to permit linking proprietary applications with the library. If this is what you want to do, use the GNU Lesser General Public License instead of this License.

[GNU LESSER GENERAL PUBLIC LICENSE]

Version 2.1, February 1999

Copyright © 1991, 1999 Free Software Foundation, Inc.
51 Franklin Street, Fifth Floor, Boston, MA 02110-1301 USA
Everyone is permitted to copy and distribute verbatim copies of this license document, but changing it is not allowed.

[This is the first released version of the Lesser GPL. It also counts as the successor of the GNU Library Public License, version 2, hence the version number 2.1.]

Preamble

The licenses for most software are designed to take away your freedom to share and change it. By contrast, the GNU General Public Licenses are intended to guarantee your freedom to share and change free software – to make sure the software is free for all its users. This license, the Lesser General Public License, applies to some specially designated software packages – typically libraries – of the Free Software Foundation and other authors who decide to use it. You can use it too, but we suggest you first think carefully about whether this license or the ordinary General Public License is the better strategy to use in any particular case, based on the explanations below.

When we speak of free software, we are referring to freedom of use, not price. Our General Public Licenses are designed to make sure that you have the freedom to distribute copies of free software (and charge for this service if you wish); that you receive source code or can get it if you want it; that you can change the software and use pieces of it in new free programs; and that you are informed that you can do these things.

To protect your rights, we need to make restrictions that forbid distributors to deny you these rights or to ask you to surrender these rights. These restrictions translate to certain responsibilities for you if you distribute copies of the library or if you modify it.

For example, if you distribute copies of the library, whether gratis or for a fee, you must give the recipients all the rights that we gave you. You must make sure that they, too, receive or can get the source code. If you link other code with the library, you must provide complete object files to the recipients,

so that they can relink them with the library after making changes to the library and recompiling it. And you must show them these terms so they know their rights. We protect your rights with a two-step method: (1) we copyright the library, and (2) we offer you this license, which gives you legal permission to copy, distribute and/or modify the library.

To protect each distributor, we want to make it very clear that there is no warranty for the free library. Also, if the library is modified by someone else and passed on, the recipients should know that what they have is not the original version, so that the original author's reputation will not be affected by problems that might be introduced by others.

Finally, software patents pose a constant threat to the existence of any free program. We wish to make sure that a company cannot effectively restrict the users of a free program by obtaining a restrictive license from a patent holder. Therefore, we insist that any patent license obtained for a version of the library must be consistent with the full freedom of use specified in this license.

Most GNU software, including some libraries, is covered by the ordinary GNU General Public License. This license, the GNU Lesser General Public License, applies to certain designated libraries, and is quite different from the ordinary General Public License. We use this license for certain libraries in order to permit linking those libraries into non-free programs.

When a program is linked with a library, whether statically or using a shared library, the combination of the two is legally speaking a combined work, a derivative of the original library. The ordinary General Public License therefore permits such linking only if the entire combination fits its criteria of freedom. The Lesser General Public License permits more lax criteria for linking other code with the library. We call this license the "Lesser" General Public License because it does Less to protect the user's freedom than the ordinary General Public License. It also provides other free software developers Less of an advantage over competing non-free programs. These disadvantages are the reason we use the ordinary General Public License for many libraries. However, the Lesser license provides advantages in certain special circumstances.

For example, on rare occasions, there may be a special need to encourage the widest possible use of a certain library, so that it becomes a de-facto standard. To achieve this, non-free programs must be allowed to use the library. A more frequent case is that a free library does the same job as widely used non-free libraries. In this case, there is little to gain by limiting the free library to free software only, so we use the Lesser General Public License.

In other cases, permission to use a particular library in non-free programs enables a greater number of people to use a large body of free software.

For example, permission to use the GNU C Library in non-free programs enables many more people to use the whole GNU operating system, as well as its variant, the GNU Linux operating system. Although the Lesser General Public License is Less protective of the users' freedom, it does ensure that the user of a program that is linked with the Library has the freedom and the wherewithal to run that program using a modified version of the Library.

The precise terms and conditions for copying, distribution and modification follow. Pay close attention to the difference between a "work based on the library" and a "work that uses the library". The former contains code derived from the library, whereas the latter must be combined with the library in order to run.

GNU LESSER GENERAL PUBLIC LICENSE

TERMS AND CONDITIONS FOR COPYING, DISTRIBUTION AND MODIFICATION

0. This License Agreement applies to any software library or other program which contains a notice placed by the copyright holder or other authorized party saying it may be distributed under the terms of this Lesser General Public License (also called "this License"). Each licensee is addressed as "you".

A "library" means a collection of software functions and/or data prepared so as to be conveniently linked with application programs (which use some of those functions and data) to form executables.

The "Library", below, refers to any such software library or work which has been distributed under these terms. A "work based on the Library" means either the Library or any derivative work under copyright law: that is to say, a work containing the Library or a portion of it, either verbatim or with modifications and/or translated straightforwardly into another language. (Hereinafter, translation is included without limitation in the term "modification".)

"Source code" for a work means the preferred form of the work for making modifications to it. For a library, complete source

code means all the source code for all modules it contains, plus any associated interface definition files, plus the scripts used to control compilation and installation of the library.

Activities other than copying, distribution and modification are not covered by this License; they are outside its scope. The act of running a program using the Library is not restricted, and output from such a program is covered only if its contents constitute a work based on the Library (independent of the use of the Library in a tool for writing it). Whether that is true depends on what the Library does and what the program that uses the Library does.

1. You may copy and distribute verbatim copies of the Library's complete source code as you receive it, in any medium, provided that you conspicuously and appropriately publish on each copy an appropriate copyright notice and disclaimer of warranty; keep intact all the notices that refer to this License and to the absence of any warranty; and distribute a copy of this License along with the Library.

You may charge a fee for the physical act of transferring a copy, and you may at your option offer warranty protection in exchange for a fee.

2. You may modify your copy or copies of the Library or any portion of it, thus forming a work based on the Library, and copy and distribute such modifications or work under the terms of Section 1 above, provided that you also meet all of these conditions:

a) The modified work must itself be a software library.

b) You must cause the files modified to carry prominent notices stating that you changed the files and the date of any change.

c) You must cause the whole of the work to be licensed at no charge to all third parties under the terms of this License.

d) If a facility in the modified Library refers to a function or a table of data to be supplied by an application program that uses the facility, other than as an argument passed when the facility is invoked, then you must make a good faith effort to ensure that, in the event an application does not supply such function or table, the facility still operates, and performs whatever part of its purpose remains meaningful. (For example, a function in a library to compute square roots has a purpose that is entirely well-defined independent of the application. Therefore, Subsection 2d requires that any application-supplied function or table used by this function must be optional: if the application does not supply it, the square root function must still compute square roots.)

These requirements apply to the modified work as a whole. If identifiable sections of that work are not derived from the Library, and can be reasonably considered independent and separate works in themselves, then this License, and its terms, do not apply to those sections when you distribute them as separate works. But when you distribute the same sections as part of a whole which is a work based on the Library, the distribution of the whole must be on the terms of this License, whose permissions for other licensees extend to the entire whole, and thus to each and every part regardless of who wrote it.

Thus, it is not the intent of this section to claim rights or contest your rights to work written entirely by you; rather, the intent is to exercise the right to control the distribution of derivative or collective works based on the Library.

In addition, mere aggregation of another work not based on the Library with the Library (or with a work based on the Library) on a volume of a storage or distribution medium does not bring the other work under the scope of this License.

3. You may opt to apply the terms of the ordinary GNU General Public License instead of this License to a given copy of the Library. To do this, you must alter all the notices that refer to this License, so that they refer to the ordinary GNU General Public License, version 2, instead of to this License. (If a newer version than version 2 of the ordinary GNU General Public License has appeared, then you can specify that version instead if you wish.) Do not make any other change in these notices.

Once this change is made in a given copy, it is irreversible for that copy, so the ordinary GNU General Public License applies to all subsequent copies and derivative works made from that copy. This option is useful when you wish to copy part of the code of the Library into a program that is not a library.

4. You may copy and distribute the Library (or a portion or derivative of it, under Section 2) in object code or executable form under the terms of Sections 1 and 2 above provided that you accompany it with the complete corresponding machine-readable source code, which must be distributed under the terms of Sections 1 and 2 above on a medium customarily used for software interchange.

If distribution of object code is made by offering access to

copy from a designated place, then offering equivalent access to copy the source code from the same place satisfies the requirement to distribute the source code, even though third parties are not compelled to copy the source along with the object code.

5. A program that contains no derivative of any portion of the Library, but is designed to work with the Library by being compiled or linked with it, is called a "work that uses the Library". Such a work, in isolation, is not a derivative work of the Library, and therefore falls outside the scope of this License.

6. However, linking a "work that uses the Library" with the Library creates an executable that is a derivative of the Library (because it contains portions of the Library), rather than a "work that uses the library". The executable is therefore covered by this License. Section 6 states terms for distribution of such executables.

When a "work that uses the Library" uses material from a header file that is part of the Library, the object code for the work may be a derivative work of the Library even though the source code is not. Whether this is true is especially significant if the work can be linked without the Library, or if the work is itself a library. The threshold for this to be true is not precisely defined by law.

7. If such an object file uses only numerical parameters, data structure layouts and accessors, and small macros and small inline functions (ten lines or less in length), then the use of the object file is unrestricted, regardless of whether it is legally a derivative work. (Executables containing this object code plus portions of the Library will still fall under Section 6.)

Otherwise, if the work is a derivative of the Library, you may distribute the object code for the work under the terms of Section 6. Any executables containing that work also fall under Section 6, whether or not they are linked directly with the Library itself.

8. As an exception to the Sections above, you may also combine or link a "work that uses the Library" with the Library to produce a work containing portions of the Library, and distribute that work under terms of your choice, provided that the terms permit modification of the work for the customer's own use and reverse engineering for debugging such modifications.

You must give prominent notice with each copy of the work that the Library is used in it and that the Library and its use are covered by this License. You must supply a copy of this License. If the work during execution displays copyright notices, you must include the copyright notice for the Library among them, as well as a reference directing the user to the copy of this License. Also, you must do one of these things:

a) Accompany the work with the complete corresponding machine-readable source code for the Library including whatever changes were used in the work (which must be distributed under Sections 1 and 2 above); and, if the work is an executable linked with the Library, with the complete machine-readable "work that uses the Library", as object code and/or source code, so that the user can modify the Library and then relink to produce a modified executable containing the modified Library. (It is understood that the user who changes the contents of definitions files in the Library will not necessarily be able to recompile the application to use the modified definitions.)

b) Use a suitable shared library mechanism for linking with the Library. A suitable mechanism is one that (1) uses at run time a copy of the library already present on the user's computer system, rather than copying library functions into the executable, and (2) will operate properly with a modified version of the library, if the user installs one, as long as the modified version is interface-compatible with the version that the work was made with.

c) Accompany the work with a written offer, valid for at least three years, to give the same user the materials specified in Subsection 6a, above, for a charge no more than the cost of performing this distribution.

d) If distribution of the work is made by offering access to copy from a designated place, offer equivalent access to copy the above specified materials from the same place.

e) Verify that the user has already received a copy of these materials or that you have already sent this user a copy.

For an executable, the required form of the "work that uses the Library" must include any data and utility programs needed for reproducing the executable from it. However, as a special exception, the materials to be distributed need not include anything that is normally distributed (in either source or binary form) with the major components (compiler, kernel, and so on) of the operating system on which the executable runs, unless that component itself accompanies the executable.

It may happen that this requirement contradicts the license restrictions of other proprietary libraries that do not normally accompany the operating system. Such a contradiction means you cannot use both them and the Library together in an executable that you distribute.

9. You may place library facilities that are a work based on the Library side-by-side in a single library together with other library facilities not covered by this License, and distribute such a combined library, provided that the separate distribution of the work based on the Library and of the other library facilities is otherwise permitted, and provided that you do these two things:

a) Accompany the combined library with a copy of the same work based on the Library, uncombined with any other library facilities. This must be distributed under the terms of the Sections above.

b) Give prominent notice with the combined library of the fact that part of it is a work based on the Library, and explaining where to find the accompanying uncombined form of the same work.

10. You may not copy, modify, sublicense, link with, or distribute the Library except as expressly provided under this License. Any attempt otherwise to copy, modify, sublicense, link with, or distribute the Library is void, and will automatically terminate your rights under this License. However, parties who have received copies, or rights, from you under this License will not have their licenses terminated so long as such parties remain in full compliance.

11. You are not required to accept this License, since you have not signed it. However, nothing else grants you permission to modify or distribute the Library or its derivative works. These actions are prohibited by law if you do not accept this License. Therefore, by modifying or distributing the Library (or any work based on the Library), you indicate your acceptance of this License to do so, and all its terms and conditions for copying, distributing or modifying the Library or works based on it.

12. Each time you redistribute the Library (or any work based on the Library), the recipient automatically receives a license from the original licensor to copy, distribute, link with or modify the Library subject to these terms and conditions. You may not impose any further restrictions on the recipients' exercise of the rights granted herein. You are not responsible for enforcing compliance by third parties with this License.

13. If, as a consequence of a court judgment or allegation of patent infringement or for any other reason (not limited to patent issues), conditions are imposed on you (whether by court order, agreement or otherwise) that contradict the conditions of this License, they do not excuse you from the conditions of this License. If you cannot distribute so as to satisfy simultaneously your obligations under this License and any other pertinent obligations, then as a consequence you may not distribute the Library at all. For example, if a patent license would not permit royalty-free redistribution of the Library by all those who receive copies directly or indirectly through you, then the only way you could satisfy both it and this License would be to refrain entirely from distribution of the Library. If any portion of this section is held invalid or unenforceable under any particular circumstance, the balance of the section is intended to apply, and the section as a whole is intended to apply in other circumstances.

It is not the purpose of this section to induce you to infringe any patents or other property right claims or to contest validity of any such claims; this section has the sole purpose of protecting the integrity of the free software distribution system which is implemented by public license practices. Many people have made generous contributions to the wide range of software distributed through that system in reliance on consistent application of that system; it is up to the author donor to decide if he or she is willing to distribute software through any other system and a licensee cannot impose that choice.

This section is intended to make thoroughly clear what is believed to be a consequence of the rest of this License.

14. If the distribution and/or use of the Library is restricted in certain countries either by patents or by copyrighted interfaces, the original copyright holder who places the Library under this License may add an explicit geographical distribution limitation excluding those countries, so that distribution is permitted only in or among countries not thus excluded. In such case, this License incorporates the limitation as if written in the body of this License.

15. The Free Software Foundation may publish revised and/or new versions of the Lesser General Public License from time to time. Such new versions will be similar in spirit to the present version, but may differ in detail to address new problems or concerns.

Each version is given a distinguishing version number. If the Library specifies a version number of this License which applies to it and "any later version", you have the option of following the terms and conditions either of that version or of any later version published by the Free Software Foundation. If the Library does not specify a license version number, you may choose any version ever published by the Free Software Foundation.

16. If you wish to incorporate parts of the Library into other free programs whose distribution conditions are incompatible with these, write to the author to ask for permission. For software which is copyrighted by the Free Software Foundation, write to the Free Software Foundation; we sometimes make exceptions for this. Our decision will be guided by the two goals of preserving the free status of all derivatives of our free software and of promoting the sharing and reuse of software generally.

NO WARRANTY

17. BECAUSE THE LIBRARY IS LICENSED FREE OF CHARGE, THERE IS NO WARRANTY FOR THE LIBRARY, TO THE EXTENT PERMITTED BY APPLICABLE LAW. EXCEPT WHEN OTHERWISE STATED IN WRITING THE COPYRIGHT HOLDERS AND/OR OTHER PARTIES PROVIDE THE LIBRARY "AS IS" WITHOUT WARRANTY OF ANY KIND, EITHER EXPRESSED OR IMPLIED, INCLUDING, BUT NOT LIMITED TO, THE IMPLIED WARRANTIES OF MERCHANTABILITY AND FITNESS FOR A PARTICULAR PURPOSE. THE ENTIRE RISK AS TO THE QUALITY AND PERFORMANCE OF THE LIBRARY IS WITH YOU. SHOULD THE LIBRARY PROVE DEFECTIVE, YOU ASSUME THE COST OF ALL NECESSARY SERVICING, REPAIR OR CORRECTION.

18. IN NO EVENT UNLESS REQUIRED BY APPLICABLE LAW OR AGREED TO IN WRITING WILL ANY COPYRIGHT HOLDER, OR ANY OTHER PARTY WHO MAY MODIFY AND/OR REDISTRIBUTE THE LIBRARY AS PERMITTED ABOVE, BE LIABLE TO YOU FOR DAMAGES, INCLUDING ANY GENERAL, SPECIAL, INCIDENTAL OR CONSEQUENTIAL DAMAGES ARISING OUT OF THE USE OR INABILITY TO USE THE LIBRARY (INCLUDING BUT NOT LIMITED TO LOSS OF DATA OR DATA BEING RENDERED INACCURATE OR LOSSES SUSTAINED BY YOU OR THIRD PARTIES OR A FAILURE OF THE LIBRARY TO OPERATE WITH ANY OTHER SOFTWARE), EVEN IF SUCH HOLDER OR OTHER PARTY HAS BEEN ADVISED OF THE POSSIBILITY OF SUCH DAMAGES.
- END OF TERMS AND CONDITIONS

How to Apply These Terms to Your New Libraries

If you develop a new library, and you want it to be of the greatest possible use to the public, we recommend making it free software that everyone can redistribute and change. You can do so by permitting redistribution under these terms (or, alternatively, under the terms of the ordinary General Public License).

To apply these terms, attach the following notices to the library. It is safest to attach them to the start of each source file to most effectively convey the exclusion of warranty; and each file should have at least the "copyright" line and a pointer to where the full notice is found.

<one line to give the library's name and a brief idea of what it does.>

Copyright © <year> <name of author>

This library is free software; you can redistribute it and/or modify it under the terms of the GNU Lesser General Public License as published by the Free Software Foundation; either version 2.1 of the License, or (at your option) any later version. This library is distributed in the hope that it will be useful, but WITHOUT ANY WARRANTY; without even the implied warranty of MERCHANTABILITY or FITNESS FOR A PARTICULAR PURPOSE. See the GNU Lesser General Public License for more details.

You should have received a copy of the GNU Lesser General Public License along with this library; if not, write to the Free Software Foundation, Inc., 51 Franklin Street, Fifth Floor, Boston, MA 02110-1301 USA Also add information on how to contact you by electronic and paper mail. You should also get your employer (if you work as a programmer) or your school, if any, to sign a "copyright disclaimer" for the library, if necessary. Here is a sample; alter the names:

Yoyodyne, Inc., hereby disclaims all copyright interest in the library 'Frob' (a library for tweaking knobs) written by

James Random Hacker.

<signature of Ty Coon>, 1 April 1990

Ty Coon, President of Vice

That's all there is to it!

HDMI®

HIGH-DEFINITION MULTIMEDIA INTERFACE

HDMI と HDMI High-Definition Multimedia Interface という用語、および HDMI ロゴは、HDMI Licensing, LLC の米国その他の国々における商標または登録商標です。

本製品は、株式会社 ACCESS の NetFront Browser、NetFront Living Connect、NetFront Media Player を搭載しています。

ACCESS、ACCESS ロゴ、NetFront は、日本国、米国、およびその他の国における株式会社 ACCESS の登録商標または商標です。

© 2013 ACCESS CO., LTD. All rights reserved.

ACCESS™

NetFront®

本製品の一部に Independent JPEG Group が開発したモジュールが含まれています。

本ソフトウェアには株式会社 OKI ACCESS テクノロジーの RTSP モジュールが搭載されています。OKI ACCESS テクノロジーのロゴは日本およびその他の国における株式会社 OKI ACCESS テクノロジーの商標または登録商標です。



株式会社 OKI ACCESS テクノロジー

本製品の一部に Independent JPEG Group が開発したモジュールが含まれています。

本取扱説明書に記載されている企業名や製品名などの固有名詞は、各社の商標または登録商標です。また、各社の商標および登録商標について、特に注記のない場合でも、これを尊重いたします。

How to Use BD-V372

Basic Operations for Watching CATV.

1. Turn on TV and switch its video input for CATV.
2. Press Power to turn on the power to BD-V372.
3. Select a channel with CH ▲ / ▼ or with the numeric buttons.

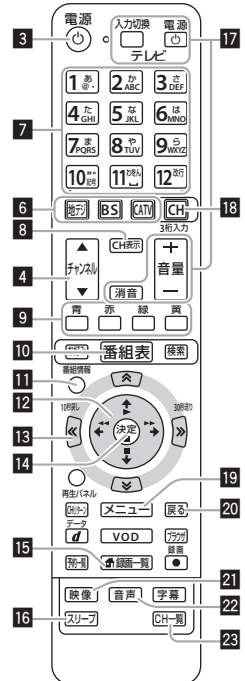
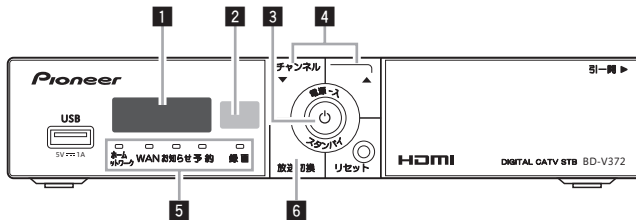

- | | |
|--|---|
| <ul style="list-style-type: none"> 1 Channel number display 2 Remote control sensor 3 Power button 4 CH ▲ / ▼ buttons 5 Indicators 6 Broadcast select buttons 7 Numeric button 8 CH display button 9 Color buttons 10 EPG (Electronic Program Guide) button 11 Program information button 12 ↑/↓/←/→ buttons | <ul style="list-style-type: none"> 13 </>/^/∨ buttons 14 Enter button 15 Home network button 16 Sleep button 17 TV control buttons 18 CH input mode button 19 Menu button 20 Return button 21 Video select button 22 Audio select button 23 CH list button |
|--|---|



長年ご使用のデジタルセットトップボックスの点検を！

| | |
|----------------|--|
| このような症状はありませんか | <ul style="list-style-type: none">・ ACアダプターが異常に熱くなる。・ 電源コードにさけめやひび割れがある。・ 電源が入ったり切れたりする。・ 本体から異常な音、熱、臭いがする。 |
|----------------|--|



| | |
|-------|---|
| ご使用中止 | 故障や事故防止のため、すぐに電源を切り、電源プラグをコンセントから抜き、必ずケーブルテレビ局にご相談ください。 |
|-------|---|